

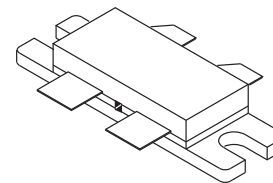

## RF POWER VERTICAL MOSFET

The VRF151G is designed for broadband commercial and military applications at frequencies to 175MHz. The high power, high gain, and broadband performance of this device make possible solid state transmitters for FM broadcast or TV channel frequency bands.



### FEATURES

- Improved Ruggedness  $V_{(BR)DSS} = 170V$
- 300W with 16dB Typical Gain @ 175MHz, 50V
- Excellent Stability & Low IMD
- Common Source Configuration
- RoHS Compliant 
- 5:1 Load VSWR Capability at Specified Operating Conditions
- Nitride Passivated
- Refractory Gold Metallization
- High Voltage Replacement for MRF151G

### Maximum Ratings

All Ratings:  $T_c = 25^\circ C$  unless otherwise specified

Symbol	Parameter	VRF151G	Unit
$V_{DSS}$	Drain-Source Voltage	170	V
$I_D$	Continuous Drain Current @ $T_c = 25^\circ C$	36	A
$V_{GS}$	Gate-Source Voltage	$\pm 40$	V
$P_D$	Total Device dissipation @ $T_c = 25^\circ C$	500	W
$T_{STG}$	Storage Temperature Range	-65 to 150	$^\circ C$
$T_J$	Operating Junction Temperature	200	

### Static Electrical Characteristics

Symbol	Parameter	Min	Typ	Max	Unit
$V_{(BR)DSS}$	Drain-Source Breakdown Voltage ( $V_{GS} = 0V, I_D = 100mA$ )	170	180		V
$V_{DS(ON)}$	On State Drain Voltage ( $I_{D(ON)} = 10A, V_{GS} = 10V$ )		2.0	3.0	
$I_{DSS}$	Zero Gate Voltage Drain Current ( $V_{DS} = 100V, V_{GS} = 0V$ )			1.0	mA
$I_{GSS}$	Gate-Source Leakage Current ( $V_{DS} = \pm 20V, V_{GS} = 0V$ )			1.0	$\mu A$
$g_{fs}$	Forward Transconductance ( $V_{DS} = 10V, I_D = 10A$ )	5.0			mhos
$V_{GS(TH)}$	Gate Threshold Voltage ( $V_{DS} = 10V, I_D = 100mA$ )	2.9	3.6	4.4	V

### Thermal Characteristics

Symbol	Characteristic	Min	Typ	Max	Unit
$R_{\theta JC}$	Junction to Case Thermal Resistance			0.35	$^\circ C/W$



**CAUTION:** These Devices are Sensitive to Electrostatic Discharge. Proper Handling Procedures Should Be Followed.

## Dynamic Characteristics

VRF151G

Symbol	Parameter	Test Conditions	Min	Typ	Max	Unit
$C_{iss}$	Input Capacitance	$V_{GS} = 0V$ $V_{DS} = 50V$ $f = 1MHz$		375		pF
$C_{oss}$	Output Capacitance			200		
$C_{rss}$	Reverse Transfer Capacitance			12		

## Functional Characteristics

Symbol	Parameter	Min	Typ	Max	Unit
$G_{PS}$	$f = 175MHz, V_{DD} = 50V, I_{DQ} = 500mA, P_{out} = 300W$	14	16		dB
$\eta_D$	$f = 175MHz, V_{DD} = 50V, I_{DQ} = 500mA, P_{out} = 300W$	50	55		%
$\Psi$	$f = 175MHz, V_{DD} = 50V, I_{DQ} = 500mA, P_{out} = 300W$ 5:1VSWR - All Phase Angles	No Degradation in Output Power			

1. To MIL-STD-1311 Version A, test method 2204B, Two Tone, Reference Each Tone

Microsemi reserves the right to change, without notice, the specifications and information contained herein.

## Typical Performance Curves

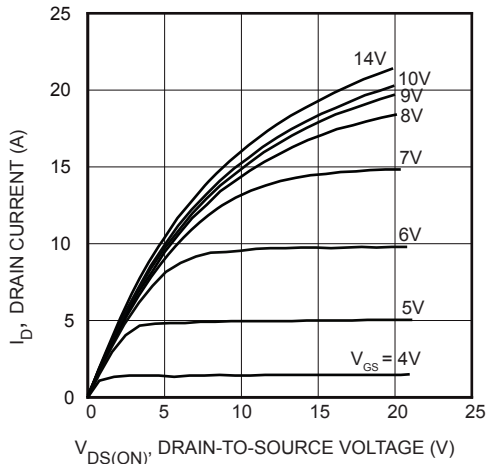

FIGURE 1, Output Characteristics

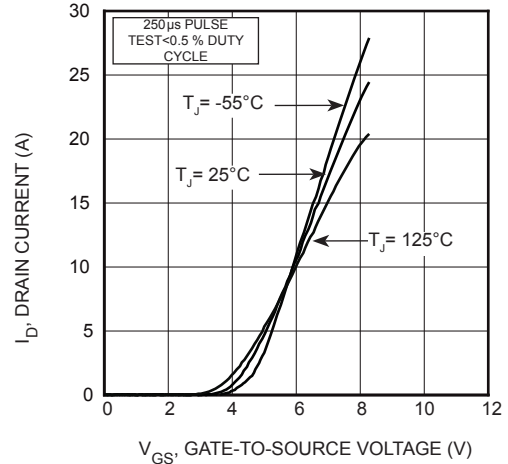

FIGURE 2, Transfer Characteristics

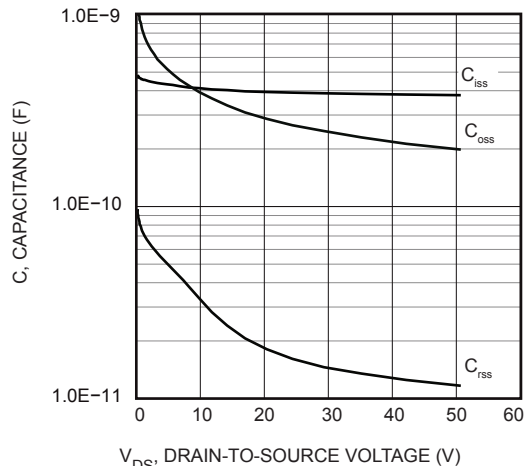

FIGURE 3, Capacitance vs Drain-to-Source Voltage

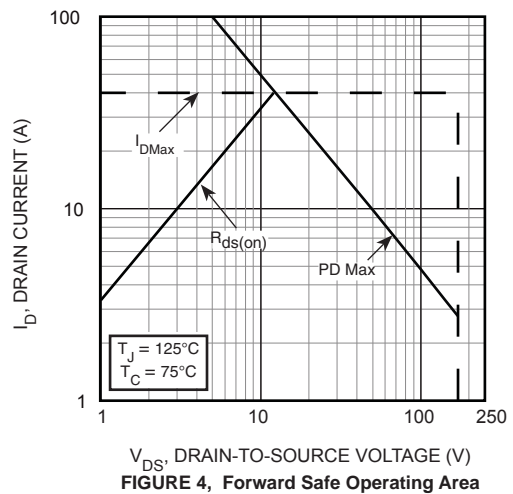
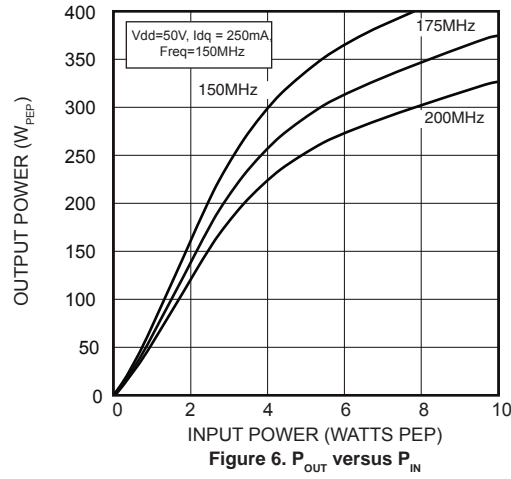
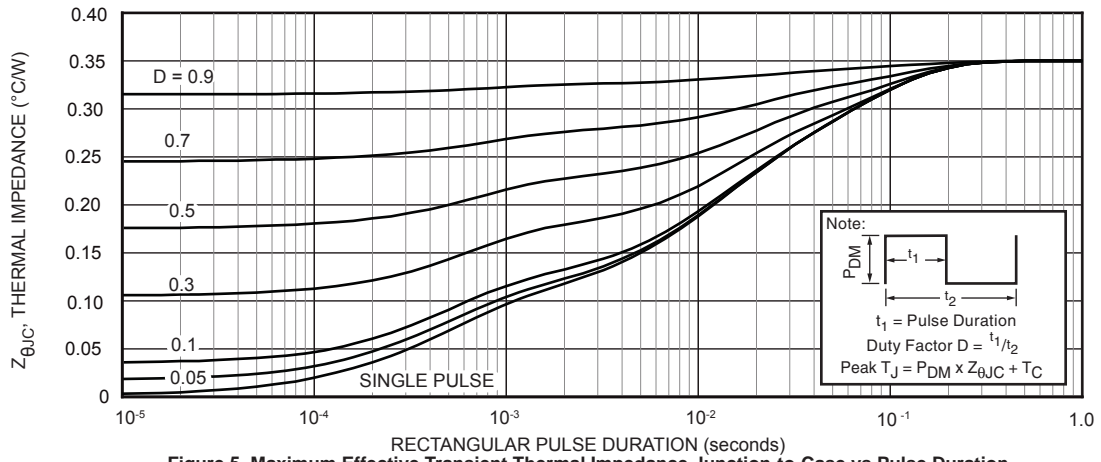

FIGURE 4, Forward Safe Operating Area



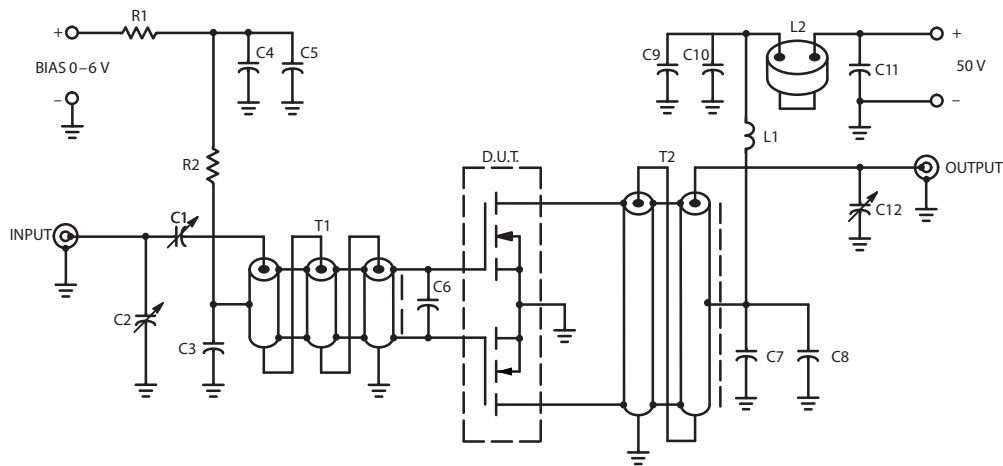
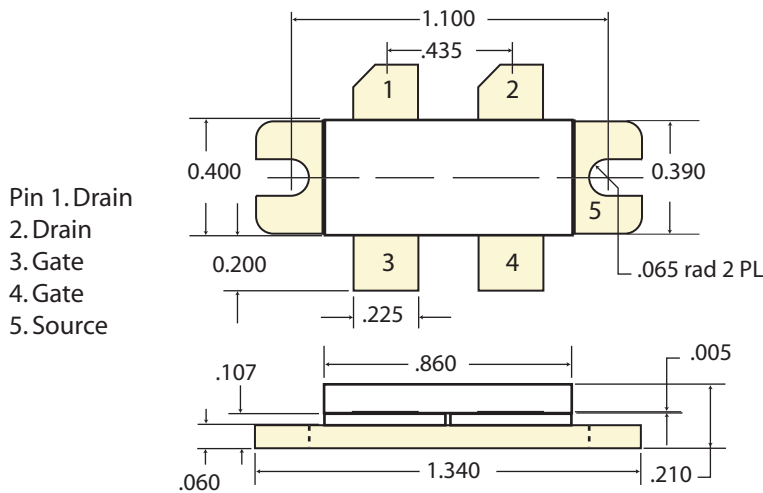

Figure 7, 175 MHz Test Circuit

- R1 - 100 Ohms, 1/2 W
  - R2 - 1.0 k Ohm, 1/2W
  - C1 - Arco 424
  - C3,C4,C7,C8,C9 - 1000 pF Chip
  - C5, C10 - 0.1  $\mu$ F Chip
  - C11 - 0.47  $\mu$ F Ceramic Chip, Kemet 1215 or Equivalent (100V)
  - C12 - Arco 422
  - L1 - 10 Turns AWG #18 Enameled Wire. Close Wound, 1/4" I.D.
  - L2 - Ferrite Beads of Suitable Material for 1.5 - 2.0  $\mu$ H Inductance
- Unless Otherwise Noted, All Chip Capacitors are ATC Type 100 or Equivalent.

- T1 - 9:1 RF Transformer, Can be made of 15 - 18 Ohms Semirigid Co - Ax, 62 - 90 Mils O.D.
  - T2 - 1:4 RF Transformer, Can be made of 16 - 18 Ohms Semirigid Co - Ax, 70 - 90 Mils O.D.
- Board Material - 0.062" Fiberglass (G10), 1 oz. Copper Clad, 2 sides,  $\epsilon_r = 5.0$
- NOTE: For stability, the input transformer T1 must be loaded with ferrite toroids or beads to increase the common mode inductance. For operation below 100 MHz. The same is required for the output transformer.



- Pin 1. Drain
- 2. Drain
- 3. Gate
- 4. Gate
- 5. Source

**HAZARDOUS MATERIAL WARNING**

The ceramic portion of the device between leads and mounting flange is beryllium oxide. Beryllium oxide dust is highly toxic when inhaled. Care must be taken during handling and mounting to avoid damage to this area. These devices must never be thrown away with general industrial or domestic waste.

Package Dimensions (inches)  
All Dimensions are  $\pm .005$