

Extrusion

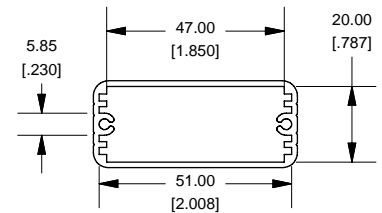

EXTRUSION DESIGNED FOR 50MM WIDE PC BOARD

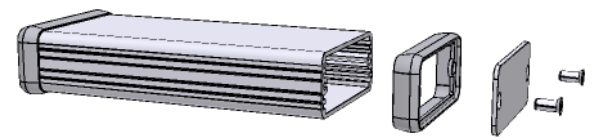
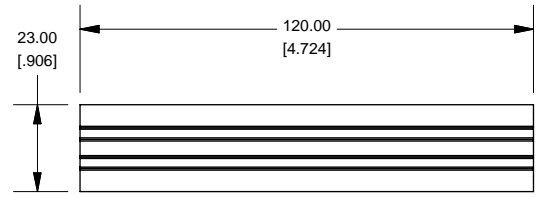

Slot Details

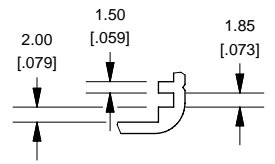

End Plate

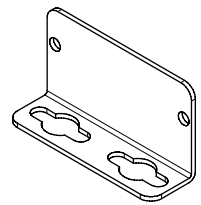
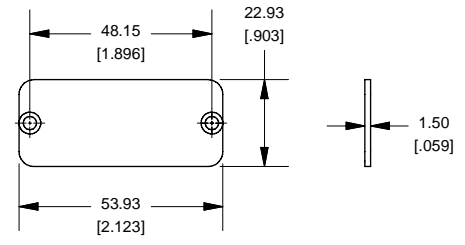

OPTIONAL FLANGE END PANELS 1455CF

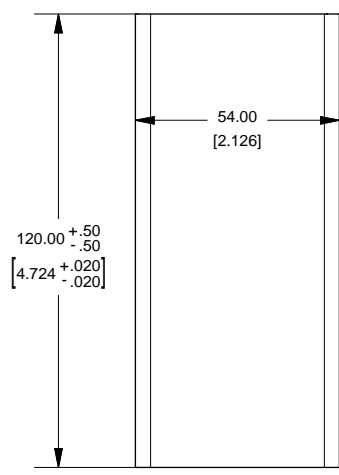

Open Bezel

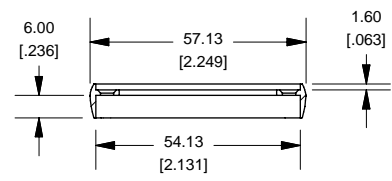
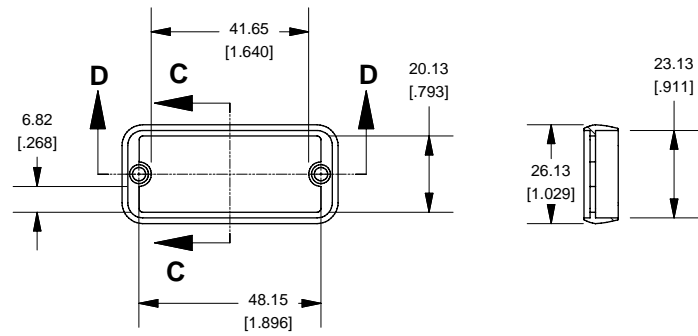

NOTE
 Purchased assembly includes box, plastic bezels, end panels, #6 Taptight screws and self adhesive rubber feet.
 Box made from Extruded Aluminum 6063.
 Bezels made with polycarbonate.

1455C1201	
PART NUMBERS	
Clear Anodized	1455C1201
Black Anodized	1455C1201BK
ACCESSORIES	
See website for accessories.	

Enclosures can be Factory Modified (Milling, Drilling, Printing etc.)
 Solid models of this enclosure available in STEP or IGES.
 Contact Factory mjm@hammondmfg.com

