

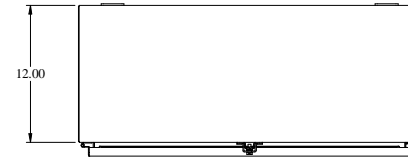

PART No. 1418N4SSM12

for more information visit
www.hammfg.com
Data subject to change without notice
Isometric drawing Not to Scale



TOP VIEW

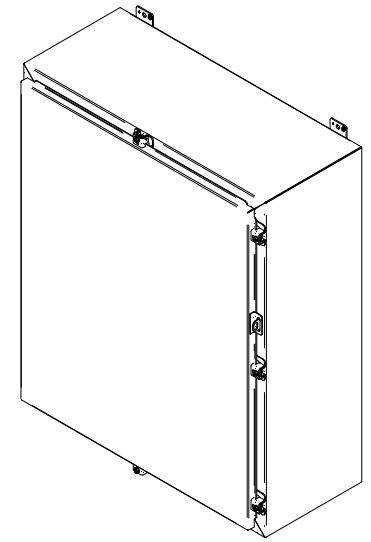

ISOMETRIC VIEW

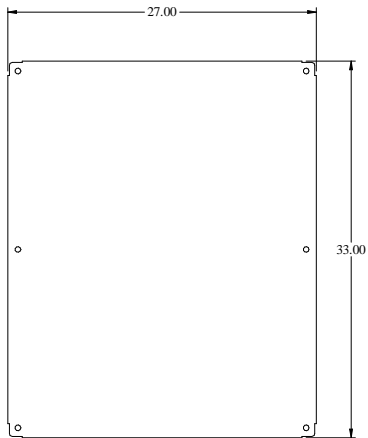

INNER PANEL



BACK VIEW

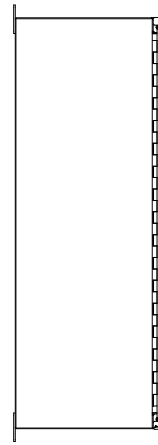

SIDE VIEW

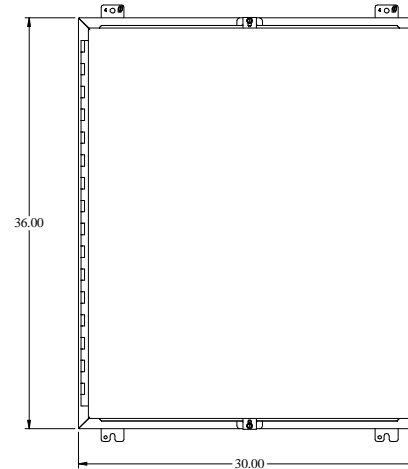

FRONT VIEW

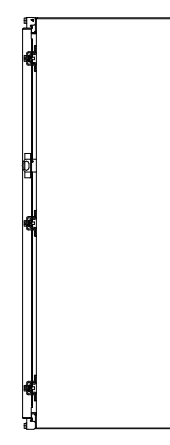

SIDE VIEW

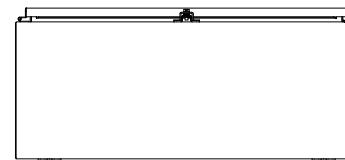

BOTTOM VIEW