

# IS32LT3170/71

## 10-TO-150MA CONSTANT-CURRENT LED DRIVER FOR AUTOMOTIVE

December 2016

### GENERAL DESCRIPTION

The IS32LT3170 and IS32LT3171 are adjustable linear current devices with excellent temperature stability. A single resistor is all that is required to set the operating current from 10mA to 150mA. The devices can operate from an input voltage from 2.5V to 42V with a minimal voltage headroom of 1V (typical). Designed with a low dropout voltage; the device can drive LED strings close to the supply voltage without switch capacitors or inductors.

The IS32LT3170/71 simplifies designs by providing a stable current without the additional requirement of input or output capacitors, inductors, FETs or diodes. The complete constant current driver requires only a current set resistor and a small PCB area making designs both efficient and cost effective.

The EN pin (1) of the IS32LT3170 can be tied to Vbat or BCM PWM signal for high side dimming. The EN Pin (1) of the IS32LT3171 can function as the PWM signal input used for low side dimming.

As a current sink it is ideal for LED lighting applications or current limiter for power supplies.

The device is provided in a lead (Pb) free, SOT23-6 package.

### FEATURES

- Low-side current sink
  - Current preset to 10mA
  - Adjustable from 10mA to 150mA with external resistor selection
- Wide input voltage range from
  - 2.5V to 42V (IS32LT3171)
  - 5V to 42V (IS32LT3170)
 with a low dropout of typical 1V
- Up to 10kHz PWM input (IS32LT3171 only)
- Protection features:
  - 0.26%/K negative temperature coefficient at high temp for thermal protection
- Up to 0.77W power dissipation in a small SOT23-6 package
- RoHS compliant (Pb-free) package
- Automotive AEC-Q100 qualified

### APPLICATIONS

- Automotive and avionic lighting
- Architectural LED lighting
- Channel letters for advertising, LED strips for decorative lighting
- Retail lighting in fridge, freezer case and vending machines
- Emergency lighting (e.g. steps lighting, exit way sign etc.)

### TYPICAL APPLICATION CIRCUIT

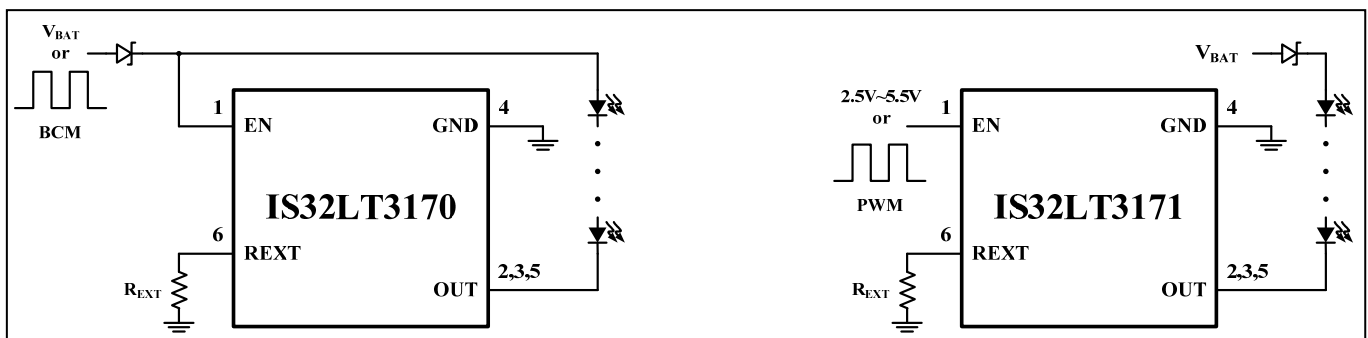
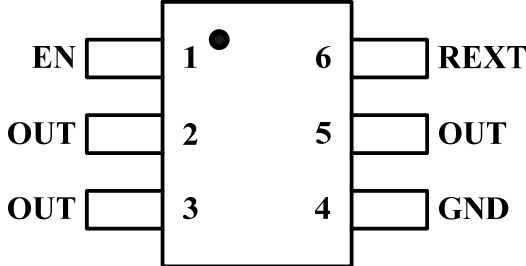

Figure 1 Typical Application Circuit

# IS32LT3170/71

## PIN CONFIGURATION

Package	Pin Configuration (Top View)
SOT23-6	

## PIN DESCRIPTION

No.	Pin	Description
1	EN	Enable pin (PWM input IS32LT3171 only).
2,3,5	OUT	Current sink.
4	GND	Ground.
6	REXT	Optional current adjust.



# IS32LT3170/71

## ORDERING INFORMATION

Automotive Range: -40°C to +125°C

Order Part No.	Package	QTY/Reel
IS32LT3170-STLA3-TR IS32LT3171-STLA3-TR	SOT-23-6, Lead-free	3000

Copyright © 2016 Integrated Silicon Solution, Inc. All rights reserved. ISSI reserves the right to make changes to this specification and its products at any time without notice. ISSI assumes no liability arising out of the application or use of any information, products or services described herein. Customers are advised to obtain the latest version of this device specification before relying on any published information and before placing orders for products.

Integrated Silicon Solution, Inc. does not recommend the use of any of its products in life support applications where the failure or malfunction of the product can reasonably be expected to cause failure of the life support system or to significantly affect its safety or effectiveness. Products are not authorized for use in such applications unless Integrated Silicon Solution, Inc. receives written assurance to its satisfaction, that:

- a.) the risk of injury or damage has been minimized;
- b.) the user assume all such risks; and
- c.) potential liability of Integrated Silicon Solution, Inc is adequately protected under the circumstances

# IS32LT3170/71

## ABSOLUTE MAXIMUM RATINGS (Note 1)

Maximum enable voltage, $V_{EN(MAX)}$ only for IS32LT3170-STLA3-TR $V_{EN(MAX)}$ only for IS32LT3171-STLA3-TR	45V 6V
Maximum output current, $I_{OUT(MAX)}$	200mA
Maximum output voltage, $V_{OUT(MAX)}$	45V
Reverse voltage between all terminals, $V_R$	0.5V
Junction to ambient, $\theta_{JA}$	130°C/W
Power dissipation, $P_{D(MAX)}$ (Note 2)	0.77W
Maximum junction temperature, $T_{JMAX}$	150°C
Storage temperature range, $T_{STG}$	-65°C ~ +150°C
Operating temperature range, $T_A=T_J$	-40°C ~ +125°C
ESD (HBM)	±2kV
ESD (CDM)	±500V

### Note 1:

Stresses beyond those listed under “Absolute Maximum Ratings” may cause permanent damage to the device. These are stress ratings only and functional operation of the device at these or any other condition beyond those indicated in the operational sections of the specifications is not implied. Exposure to absolute maximum rating conditions for extended periods may affect device reliability.

### Note 2:

Detail information please refer to package thermal de-rating curve on Page 14.

## ELECTRICAL CHARACTERISTICS

“●” This symbol in the table means these parameters are for IS32LT3170-STLA3-TR.

“○” This symbol in the table means these parameters are for IS32LT3171-STLA3-TR.

“◆” This symbol in the table means these limits are guaranteed at room temp  $T_A = T_J = 25^\circ\text{C}$ .

“◇” This symbol in the table means these limits are guaranteed at full temp range  $T_A = T_J = -40^\circ\text{C} \sim 125^\circ\text{C}$ .

Test condition is  $T_A = T_J = -40^\circ\text{C} \sim 125^\circ\text{C}$ , unless otherwise specified. (Note 3)

Symbol	Parameter	Condition	Min.	Typ.	Max.	Unit	
$V_{BD\_OUT}$	OUT pin breakdown voltage	$V_{EN} = 0V$	42			V	
$I_{EN}$	Enable current	$V_{EN} = 24V$ ●		0.35		mA	
		$V_{EN} = 3.3V$ ○		0.35			
$R_{INT}$	Internal resistor	$I_{RINT} = 10mA$		106		Ω	
$I_{OUT}$	Output current	$V_{OUT} = 1.4V, V_{EN} = 24V,$ $R_{EXT} OPEN$ ●	◆	9	10	11	mA
			◇	7.5	10	11.5	
		$V_{OUT} = 1.4V, V_{EN} = 3.3V,$ $R_{EXT} OPEN$ ○	◆	9	10	11	
			◇	7.5	10	11.5	
	Output current Range (Note 4, 5)	$V_{OUT} > 2.0V, V_{EN} = 24V,$ $R_{EXT} = 10\Omega$ ●	◆	98	112	123	mA
			◇	88	112	123	
		$V_{OUT} > 2.0V, V_{EN} = 3.3V,$ $R_{EXT} = 10\Omega$ ○	◆	98	112	123	
			◇	88	112	123	

# IS32LT3170/71

## DC CHARACTERISTICS WITH STABILIZED LED LOAD

“●” This symbol in the table means these parameters are for IS32LT3170-STLA3-TR.

“○” This symbol in the table means these parameters are for IS32LT3171-STLA3-TR.

Test condition is  $T_A = T_J = -40^{\circ}\text{C} \sim 125^{\circ}\text{C}$ , unless otherwise specified. (Note 3)

Symbol	Parameter	Condition	Min.	Typ.	Max.	Unit
$V_S$	Sufficient supply voltage on EN pin		●	5	42	V
			○	2.5	5.5	
$V_{HR}$	Lowest sufficient headroom voltage on OUT pin	$I_{OUT} = 100\text{mA}$		1	1.2	V
$\Delta I_{OUT}/I_{OUT}$ (Note 4)	Output current change versus ambient temp change	$V_{OUT} > 2.0\text{V}, V_{EN} = 24\text{V}, R_{EXT} = 10\Omega$	●	-0.26		%K
		$V_{OUT} > 2.0\text{V}, V_{EN} = 3.3\text{V}, R_{EXT} = 10\Omega$	○	-0.26		
	Output current change versus $V_{out}$	$V_{OUT} > 2.0\text{V}, V_{EN} = 24\text{V}, R_{EXT} = 10\Omega$	●	1.9		%V
		$V_{OUT} > 2.0\text{V}, V_{EN} = 3.3\text{V}, R_{EXT} = 10\Omega$	○	1.9		

**Note 3:** Production testing of the device is performed at 25°C. Functional operation of the device and parameters specified over -40°C to +125°C temperature range, are guaranteed by design and characterization.

**Note 4:** Guaranteed by design.

**Note 5:** The maximum output current is dependent on the PCB board design, air flow, ambient temperature and power dissipation in the device. Please refer to the package thermal de-rating curve on Page 14 for more detail information.

# IS32LT3170/71

## FUNCTIONAL BLOCK DIAGRAM

IS32LT3170

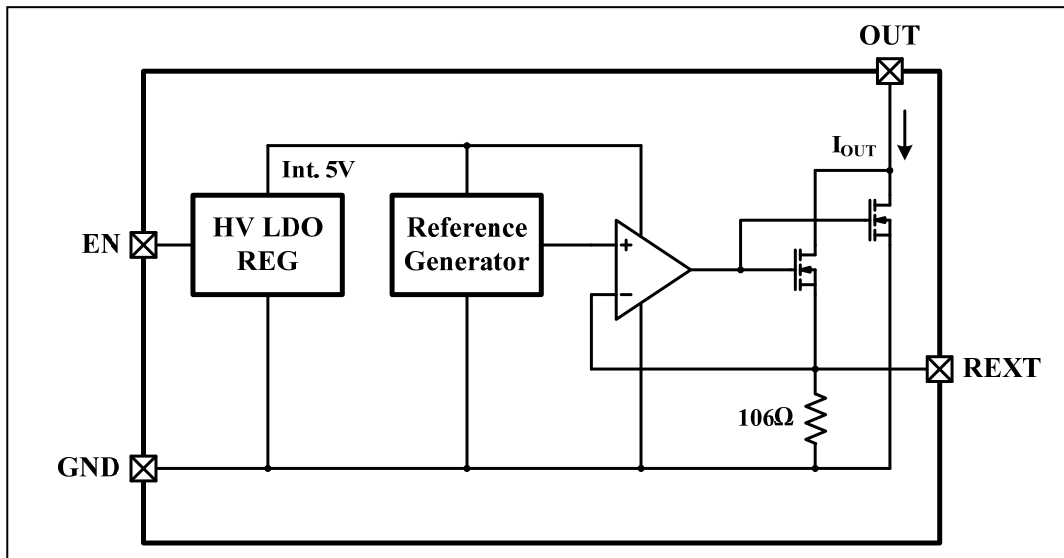

IS32LT3171

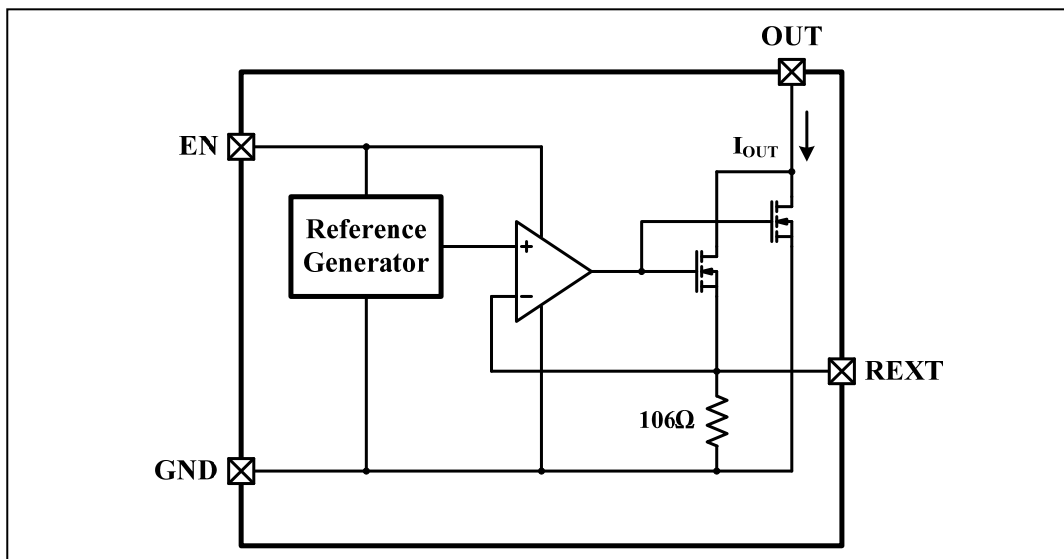

# IS32LT3170/71

## TYPICAL PERFORMANCE CHARACTERISTICS

### IS32LT3170

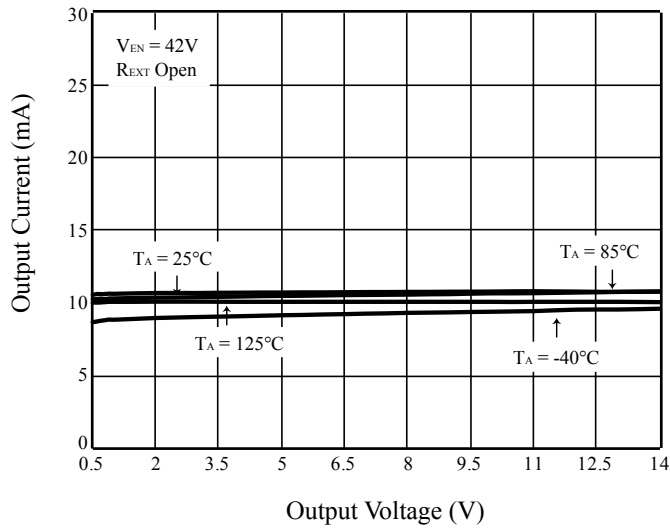

Figure 2  $I_{OUT}$  vs.  $V_{OUT}$

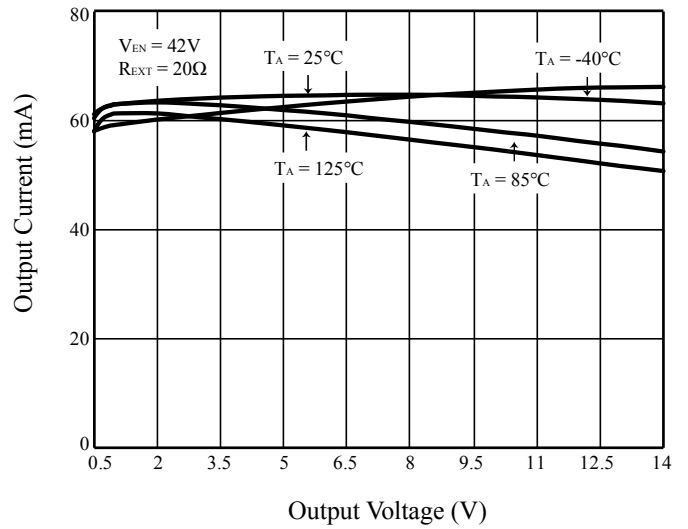

Figure 3  $I_{OUT}$  vs.  $V_{OUT}$

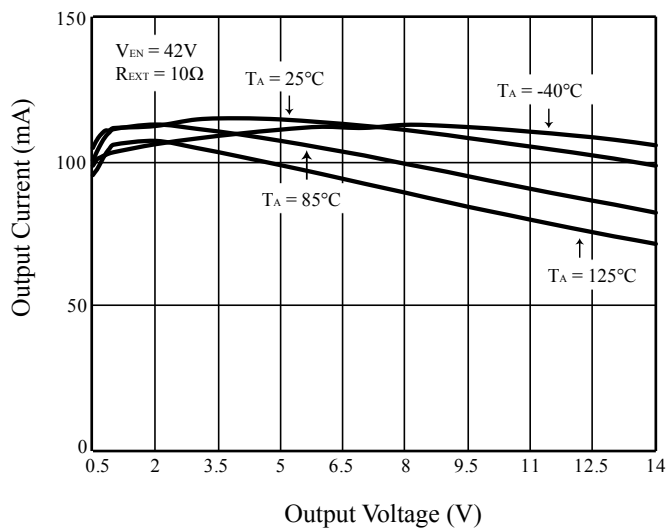

Figure 4  $I_{OUT}$  vs.  $V_{OUT}$

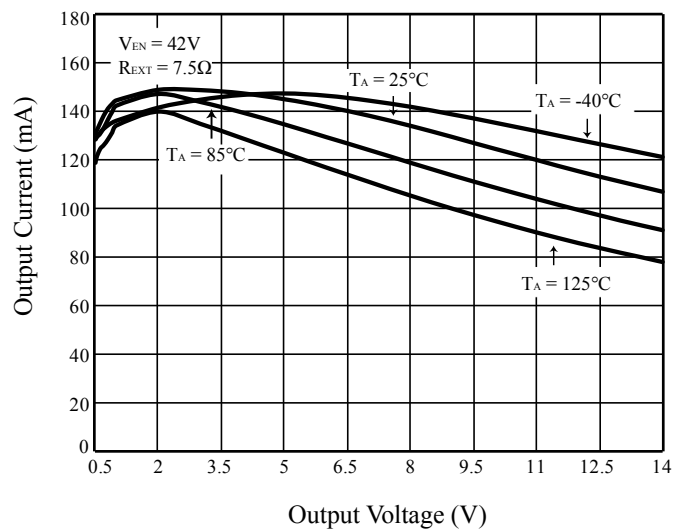

Figure 5  $I_{OUT}$  vs.  $V_{OUT}$

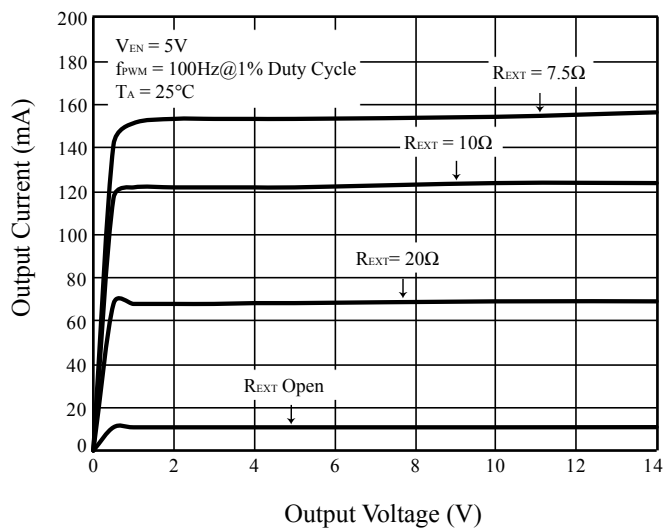

Figure 6  $I_{OUT}$  vs.  $V_{OUT}$

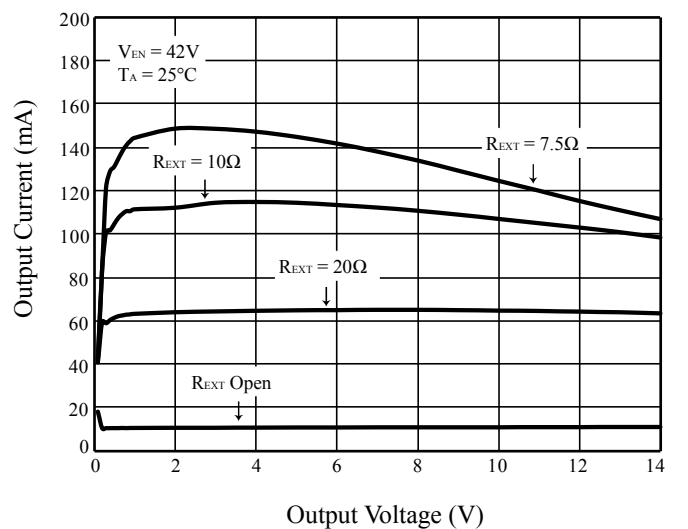

Figure 7  $I_{OUT}$  vs.  $V_{OUT}$

# IS32LT3170/71

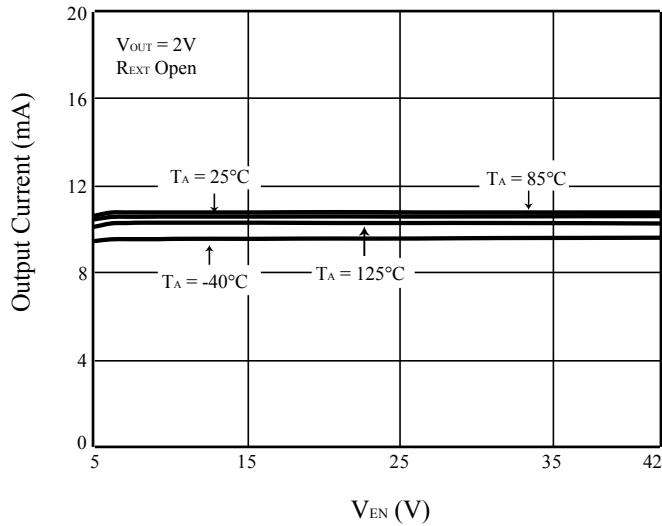

Figure 8 I<sub>OUT</sub> vs. V<sub>EN</sub>

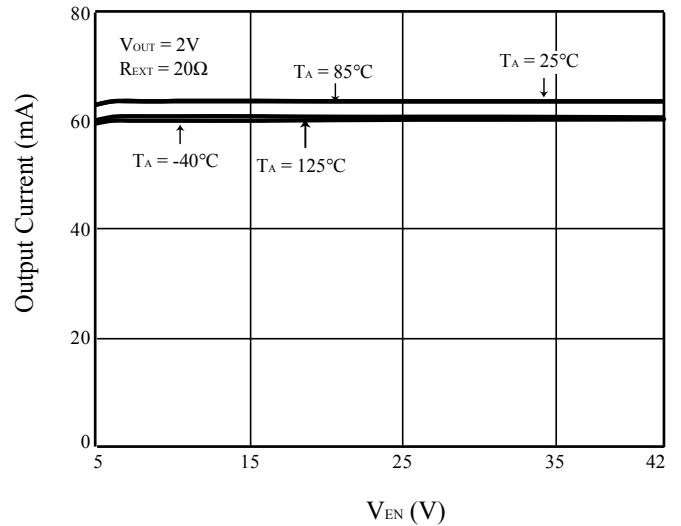

Figure 9 I<sub>OUT</sub> vs. V<sub>EN</sub>

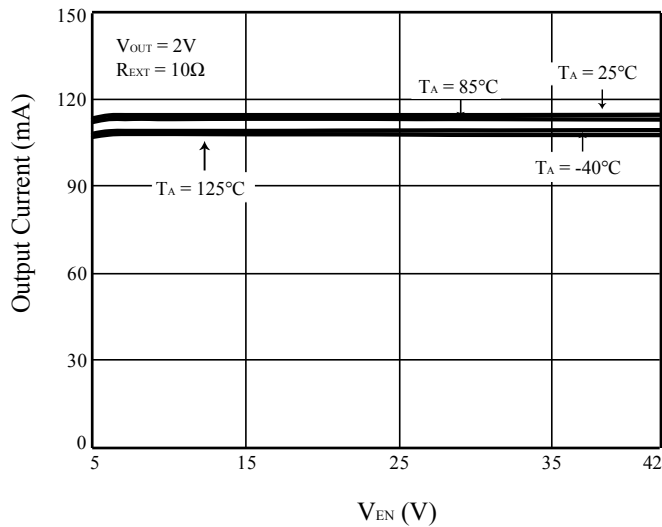

Figure 10 I<sub>OUT</sub> vs. V<sub>EN</sub>

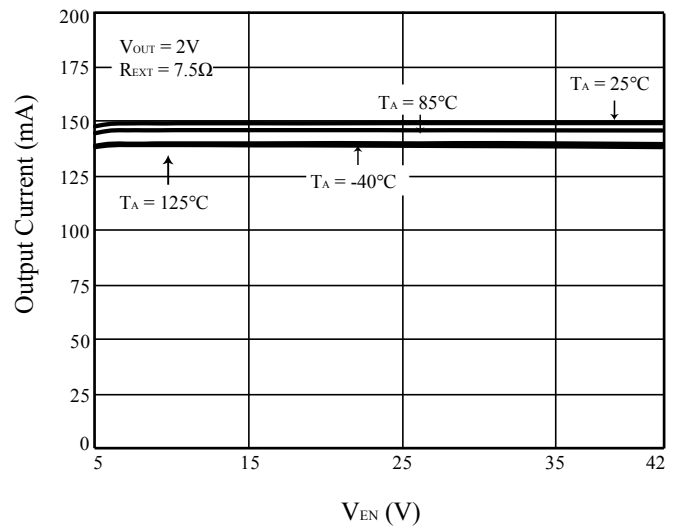

Figure 11 I<sub>OUT</sub> vs. V<sub>EN</sub>

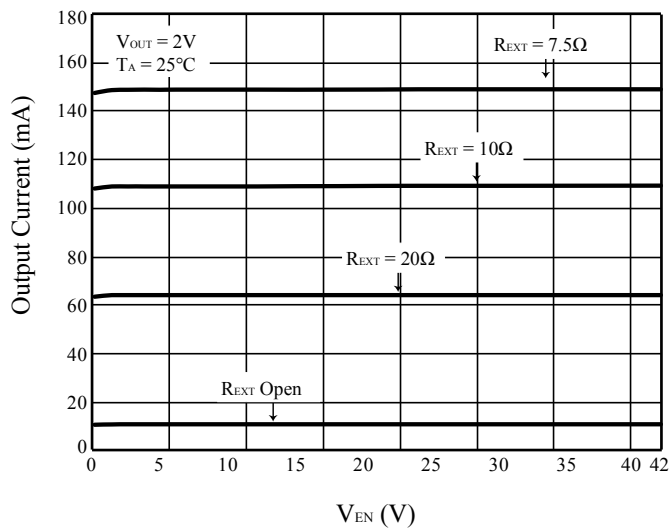

Figure 12 I<sub>OUT</sub> vs. V<sub>EN</sub>

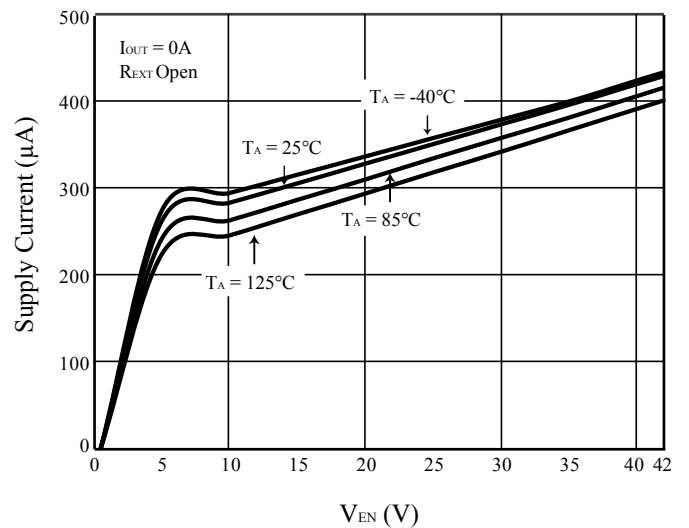

Figure 13 I<sub>EN</sub> vs. V<sub>EN</sub>



# IS32LT3170/71

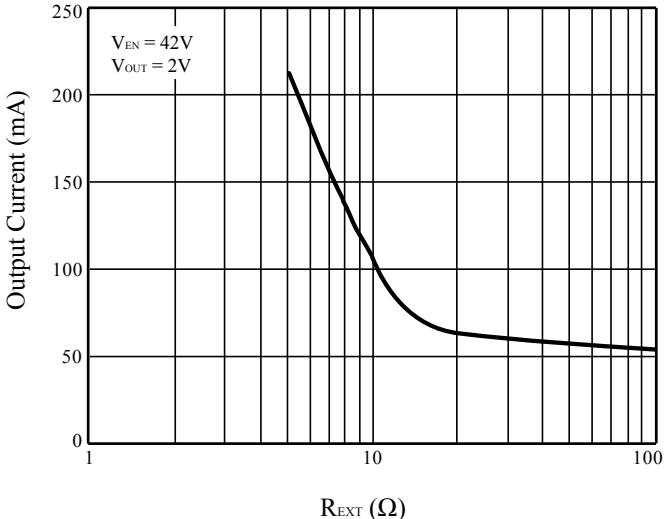

Figure 14  $I_{OUT}$  vs.  $R_{EXT}$

# IS32LT3170/71

## IS32LT3171

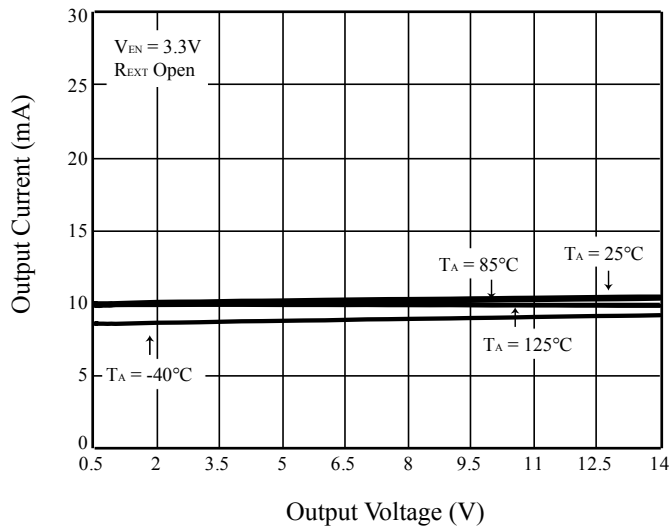

Figure 15  $I_{OUT}$  vs.  $V_{OUT}$

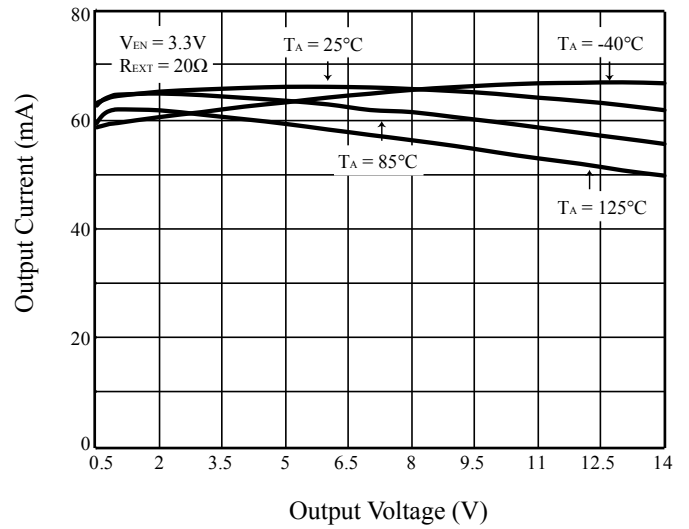

Figure 16  $I_{OUT}$  vs.  $V_{OUT}$

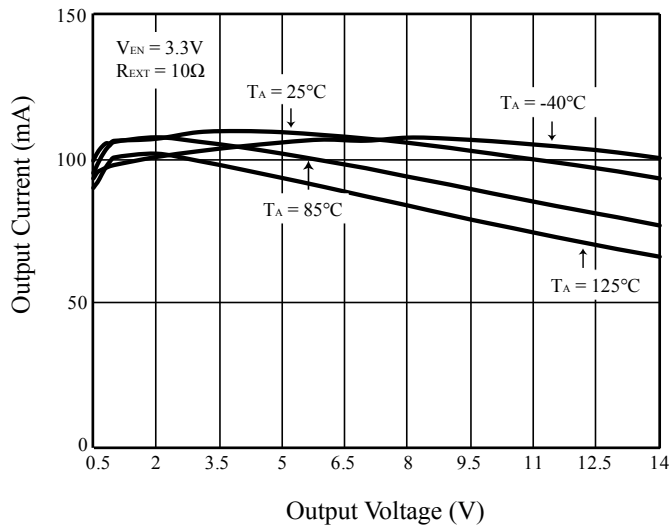

Figure 17  $I_{OUT}$  vs.  $V_{OUT}$

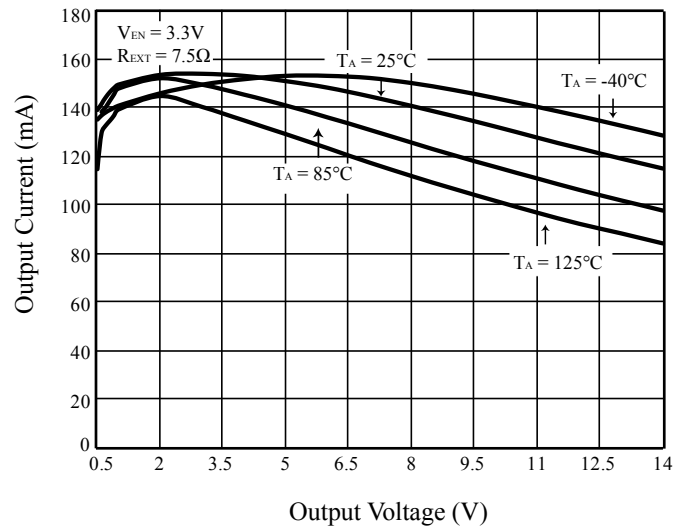

Figure 18  $I_{OUT}$  vs.  $V_{OUT}$

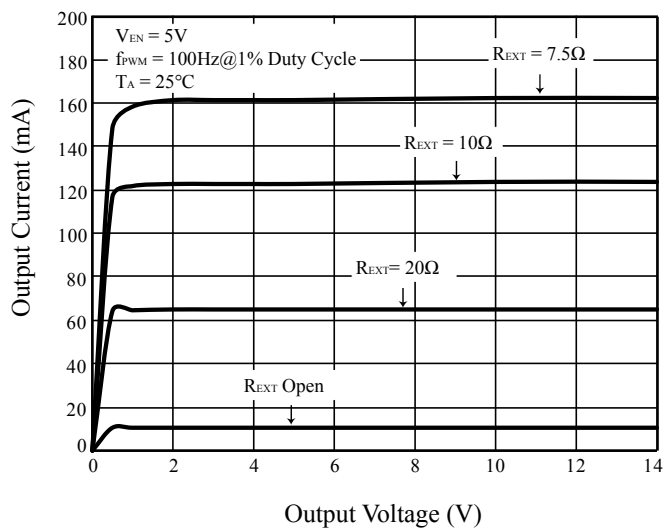

Figure 19  $I_{OUT}$  vs.  $V_{OUT}$

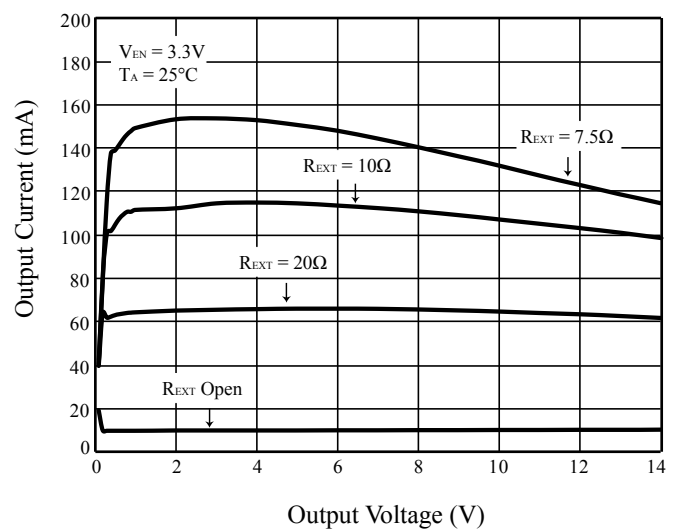

Figure 20  $I_{OUT}$  vs.  $V_{OUT}$

# IS32LT3170/71

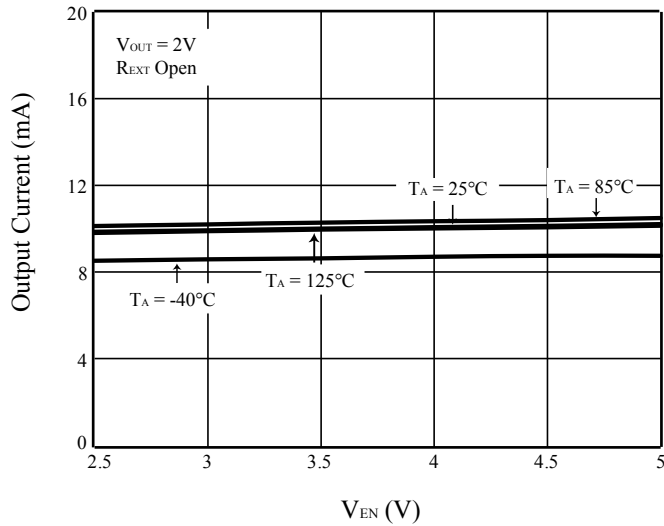

Figure 21  $I_{OUT}$  vs.  $V_{EN}$

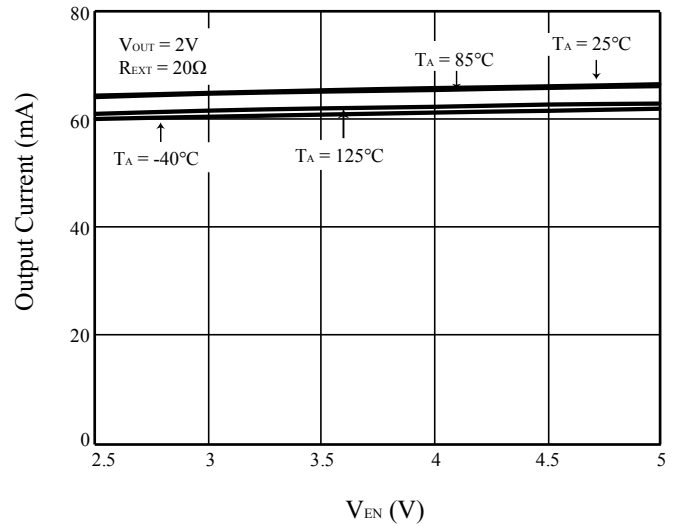

Figure 22  $I_{OUT}$  vs.  $V_{EN}$

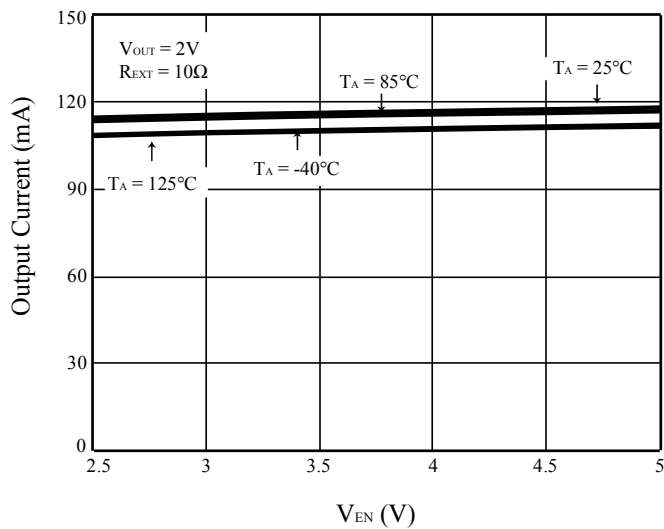

Figure 23  $I_{OUT}$  vs.  $V_{EN}$

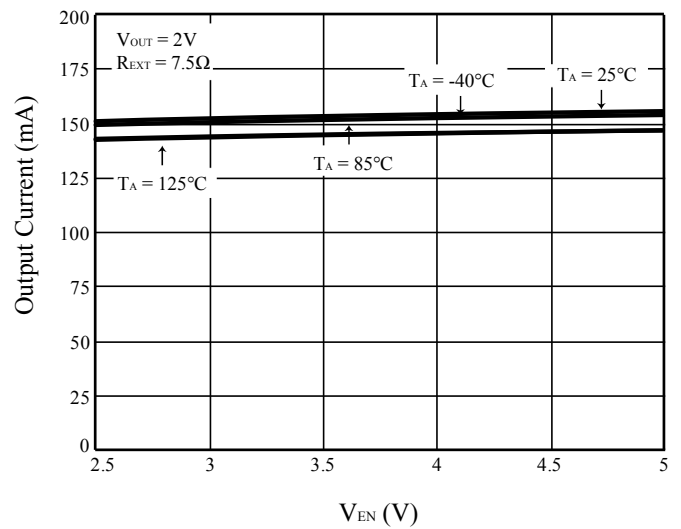

Figure 24  $I_{OUT}$  vs.  $V_{EN}$

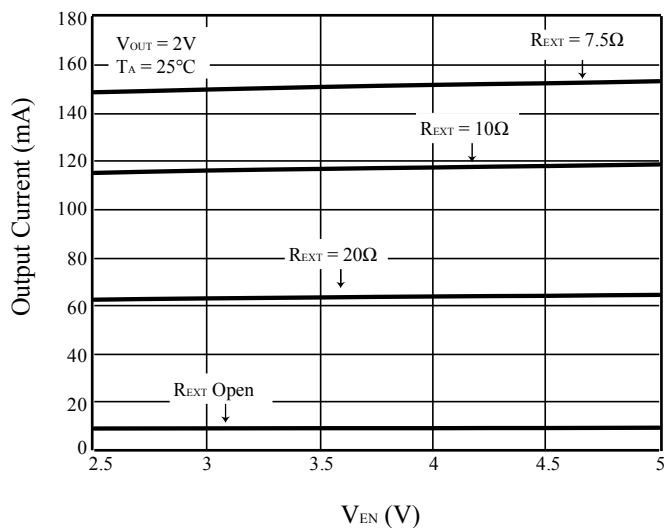

Figure 25  $I_{OUT}$  vs.  $V_{EN}$

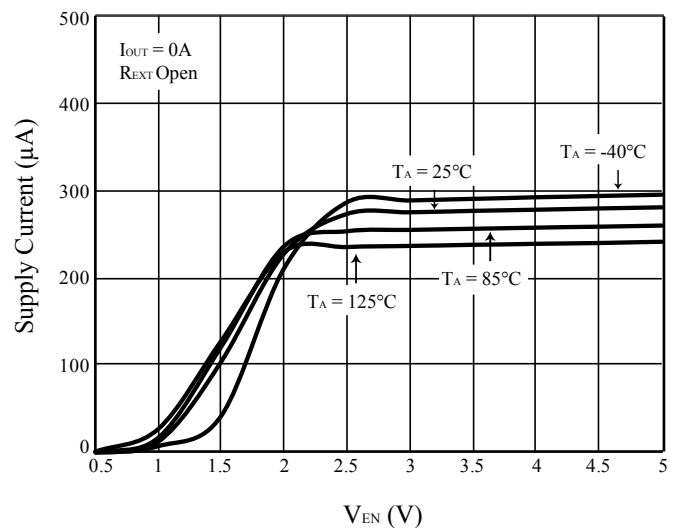
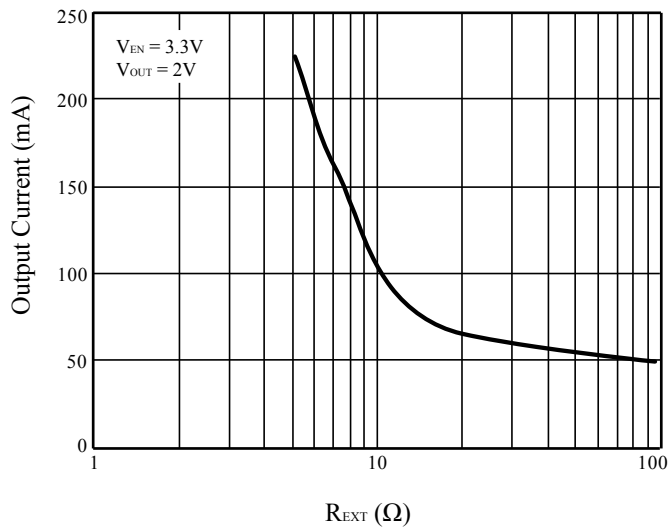
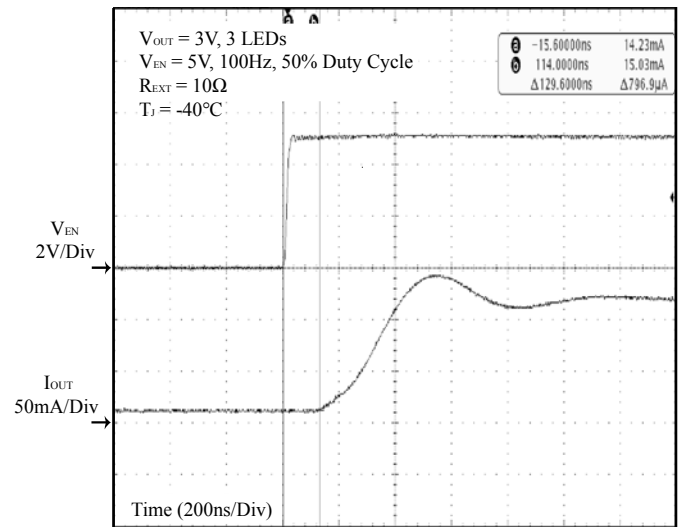

Figure 26  $I_{EN}$  vs.  $V_{EN}$

# IS32LT3170/71



**Figure 27**  $I_{OUT}$  vs.  $R_{EXT}$



**Figure 28**  $V_{EN}$  vs.  $I_{OUT}$  Delay and Rising Edge

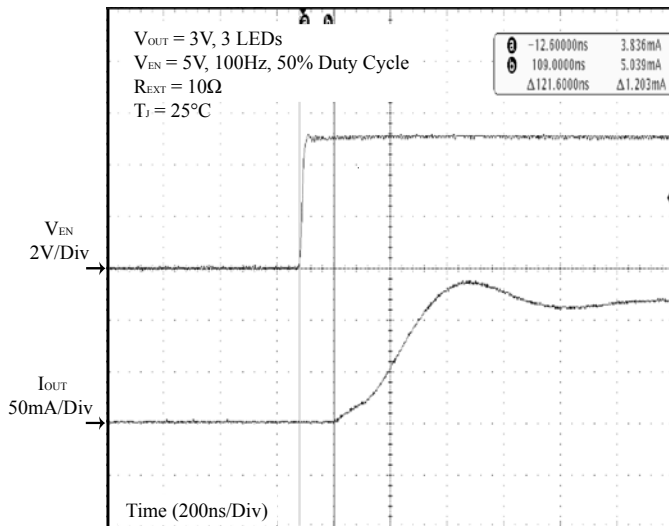

**Figure 29**  $V_{EN}$  vs.  $I_{OUT}$  Delay and Rising Edge

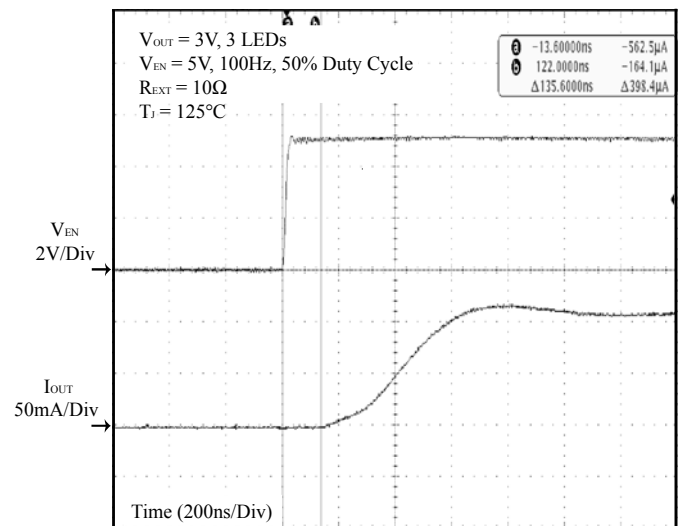

**Figure 30**  $V_{EN}$  vs.  $I_{OUT}$  Delay and Rising Edge

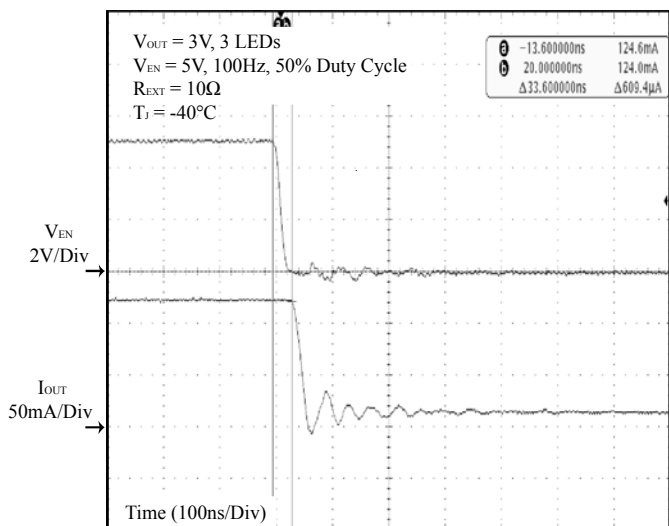

**Figure 31**  $V_{EN}$  vs.  $I_{OUT}$  Delay and Falling Edge

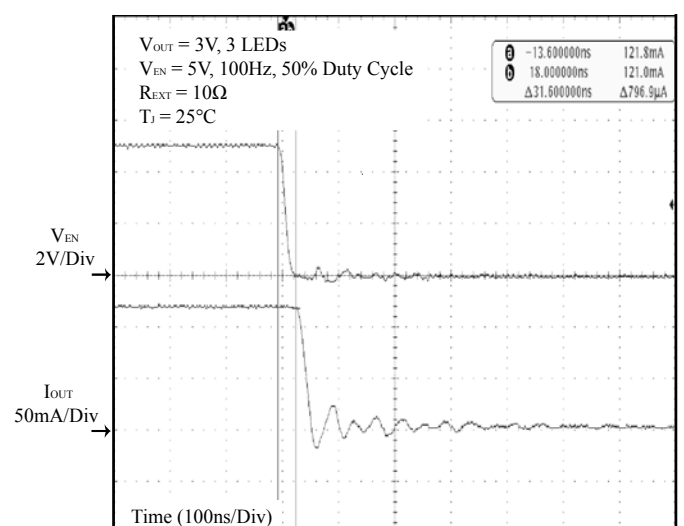

**Figure 32**  $V_{EN}$  vs.  $I_{OUT}$  Delay and Falling Edge

# IS32LT3170/71

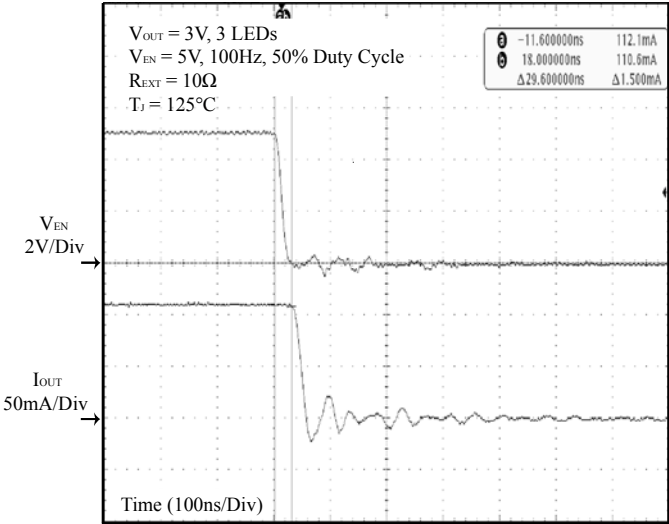

Figure 33  $V_{EN}$  vs.  $I_{OUT}$  Delay and Falling Edge

# IS32LT3170/71

## APPLICATIONS INFORMATION

IS32LT3170/71 provides an easy constant current source solution for LED lighting applications. It uses an external resistor to adjust the LED current from 10mA to 150mA. The LED current can be determined by the external resistor  $R_{EXT}$  as Equation (1):

$$R_{EXT} = \frac{10mA \times 106\Omega}{I_{SET} - 10mA} \quad (1)$$

Where  $I_{SET}$  is in mA.

Paralleling a low tolerance resistor  $R_{EXT}$  with the internal resistor  $R_{INT}$  will improve the overall accuracy of the current sense resistance. The resulting output current will vary slightly lower due to the negative temperature coefficient (NTC) resulting from the self heating of the IS32LT3170/71.

### HIGH INPUT VOLTAGE APPLICATION

When driving a long string of LEDs whose total forward voltage drop exceeds the IS32LT3170  $V_{BD\_OUT}$  limit of 42V, it is possible to stack several LEDs (such as 2 LEDs) between the EN pin and the OUT pins 2,3, and 5 so the voltage on the EN pin is higher than 5V. The remaining string of LEDs can then be placed between power supply  $+V_S$  and EN pin, (Figure 34). The number of LEDs required to stack at EN pin will depend on the LED's forward voltage drop (VF) and the  $+V_S$  value.

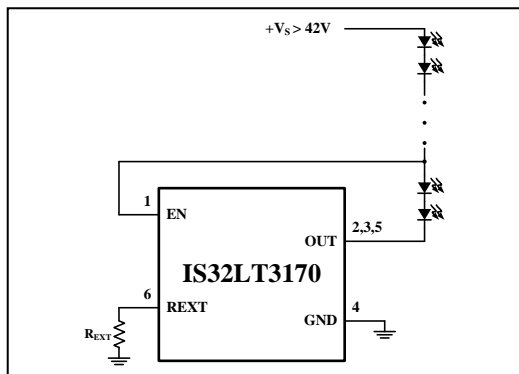

Figure 34 High Input Voltage Application Circuit

Note: when operating the IS32LT3170 at voltages exceeding the device operating limits, care needs to be taken to keep the EN pin and OUT pin voltage below 42V.

### THERMAL PROTECTION AND DISSIPATION

The IS32LT3170/71 implements thermal foldback protection to reduce the LED current when the package's thermal dissipation is exceeded and prevent "thermal runaway". The thermal foldback implements a negative temperature coefficient (NTC) of -0.26%/K.

When operating the chip at high ambient temperatures, or when driving maximum load current, care must be taken to avoid exceeding the package power dissipation limits. Exceeding the package dissipation will cause the device to enter thermal protection mode. The maximum package power dissipation can be calculated using the following Equation (2):

$$P_{D(MAX)} = \frac{T_{J(MAX)} - T_A}{\theta_{JA}} \quad (2)$$

Where  $T_{J(MAX)}$  is the maximum junction temperature,  $T_A$  is the ambient temperature, and  $\theta_{JA}$  is the junction to ambient thermal resistance; a metric for the relative thermal performance of a package.

The recommended maximum operating junction temperature,  $T_{J(MAX)}$ , is 125°C and so the maximum ambient temperature is determined by the package parameter;  $\theta_{JA}$ . The  $\theta_{JA}$  for the IS32LT3170/71 SOT23-6 package is 130°C/W.

Therefore the maximum power dissipation at  $T_A = 25^\circ\text{C}$  is:

$$P_{D(MAX)} = \frac{125^\circ\text{C} - 25^\circ\text{C}}{130^\circ\text{C/W}} \approx 0.77\text{W}$$

The actual power dissipation  $P_D$  is:

$$P_D = V_{OUT} \times I_{OUT} + V_{EN} \times I_{EN} \quad (3)$$

To ensure the performance, the die temperature ( $T_J$ ) of the IS32LT3170/71 should not exceed 125°C. The graph below gives details for the package power derating.

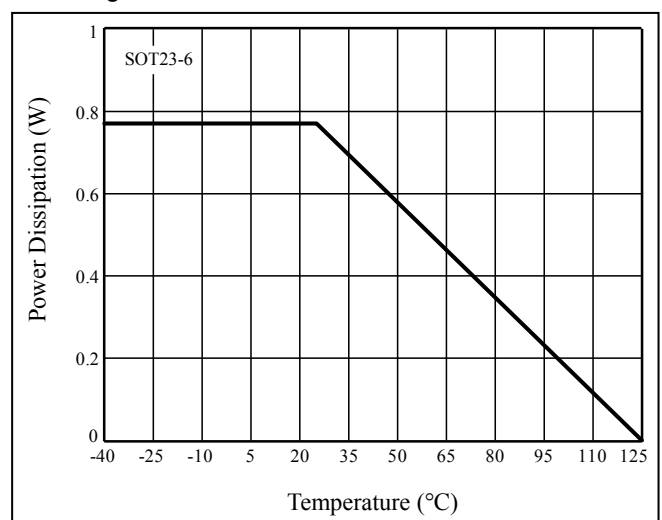
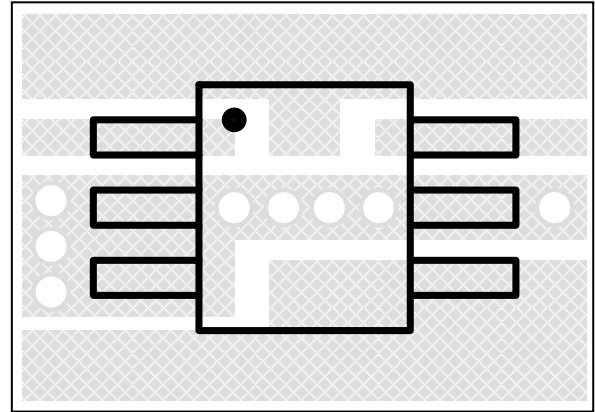

Figure 35  $P_D$  vs.  $T_A$  (SOT23-6)

## IS32LT3170/71

The thermal resistance is achieved by mounting the IS32LT3170/71 on a standard FR4 double-sided printed circuit board (PCB) with a copper area of a few square inches on each side of the board under the IS32LT3170/71. Multiple thermal vias, as shown in Figure 36, help to conduct the heat from the exposed pad of the IS32LT3170/71 to the copper on each side of the board. The thermal resistance can be reduced by using a metal substrate or by adding a heatsink.



**Figure 36** Board Via Layout For Thermal Dissipation

# IS32LT3170/71

## CLASSIFICATION REFLOW PROFILES

Profile Feature	Pb-Free Assembly
Preheat & Soak	150°C
Temperature min (T <sub>smin</sub> )	200°C
Temperature max (T <sub>smax</sub> )	60-120 seconds
Time (T <sub>smin</sub> to T <sub>smax</sub> ) (t <sub>s</sub> )	
Average ramp-up rate (T <sub>smax</sub> to T <sub>p</sub> )	3°C/second max.
Liquidous temperature (T <sub>L</sub> )	217°C
Time at liquidous (t <sub>L</sub> )	60-150 seconds
Peak package body temperature (T <sub>p</sub> )*	Max 260°C
Time (t <sub>p</sub> )** within 5°C of the specified classification temperature (T <sub>c</sub> )	Max 30 seconds
Average ramp-down rate (T <sub>p</sub> to T <sub>smax</sub> )	6°C/second max.
Time 25°C to peak temperature	8 minutes max.

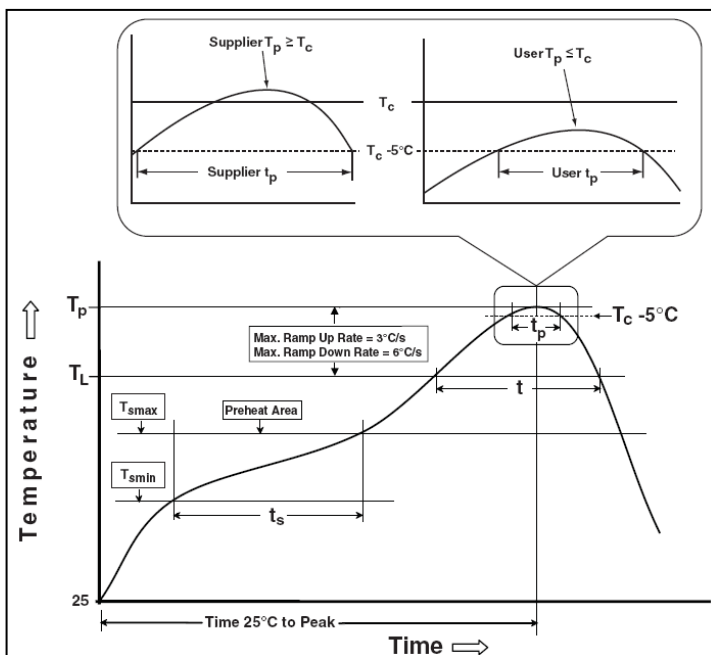

Figure 37 Classification Profile



# IS32LT3170/71

## PACKAGE INFORMATION

### SOT23-6

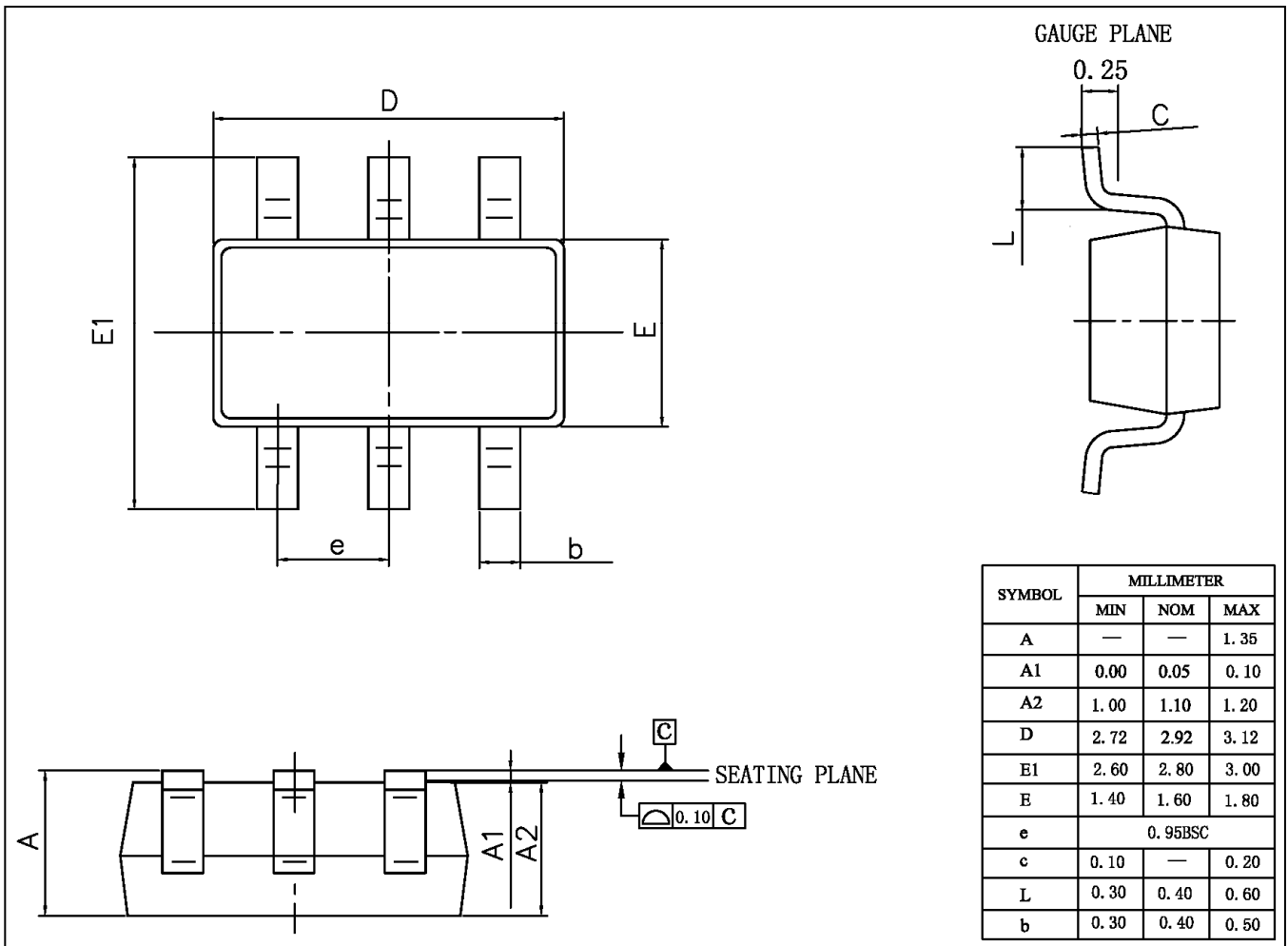

# IS32LT3170/71

## RECOMMENDED LAND PATTERN

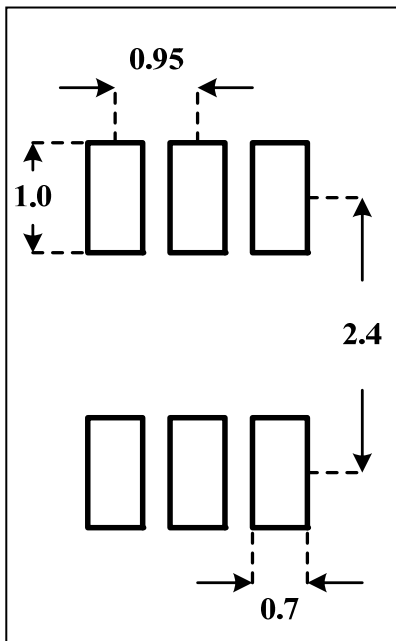

**Note:**

1. Land pattern complies to IPC-7351.
2. All dimensions in MM.
3. This document (including dimensions, notes & specs) is a recommendation based on typical circuit board manufacturing parameters. Since land pattern design depends on many factors unknown (eg. user's board manufacturing specs), user must determine suitability for use.



# IS32LT3170/71

## REVISION HISTORY

Revision	Detail Information	Date
0A	Initial release	2015.08.04
A	1. Update EC table 2. Update Automotive Grade	2016.06.24
B	1. Update $I_{OUT}$ at $R_{EXT}=10\text{ohm}$ 2. Update $\theta_{JA}$ and power dissipation	2016.12.21