

DESCRIPTION

Demonstration circuit 1031A-A is a 36V-72Vin, synchronous forward converter featuring the LTC3725/LTC3726. This circuit was designed specifically to attain a high current, low ripple, synchronously rectified forward converter to efficiently power 2.5V loads at up to 20A from a typical telecom input voltage range. This circuit features secondary-

side control of the supply eliminating the need for an optocoupler, self-starting architecture, input under-voltage lockout, and output overvoltage protection.

Design files for this circuit board are available. Call the LTC factory.

 , LTC and LT are registered trademarks of Linear Technology Corporation.

Table 1. Performance Summary (T_A = 25°C)

PARAMETER	CONDITION	VALUE
Minimum Input Voltage		36V
Maximum Input Voltage		72V
Output Voltage V _{OUT}	V _{IN} = 36V to 72V, I _{OUT} = 0A to 20A	2.5V
Maximum Output Current	200LFM Airflow	20A
Typical Output Ripple V _{OUT}	V _{IN} = 72V, I _{OUT} = 20A	100mV _{P-P}
Size	Component Area x Top Component Height	2.3" x 0.9" x 0.394"
Load Transient Response	Peak Deviation with Load Step of 10A to 20A (10A/us)	±150mV
	Settling Time	40us
Nominal Switching Frequency		200kHz
Efficiency	V _{IN} = 48V, I _{OUT} = 20A	90% Typical

OPERATING PRINCIPLES

The LTC3726 controller is used on the secondary and the LTC3725 driver with self-starting capability is used on the primary. When an input voltage is applied, the LTC3725 begins a controlled soft-start of the output voltage. As this voltage begins to rise, the LTC3726 secondary controller is quickly powered up via T1, D25, and Q27. The LTC3726 then assumes control of the output voltage by sending encoded PWM gate pulses to the LTC3725 primary driver via the small signal transformer, T2. The LTC3725 then operates as a simple driver receiving both input signals and bias power through T2.

The transition from primary to secondary control occurs seamlessly at a fraction of the output voltage. From that point on, operation and design simplifies to that of a simple buck converter. Secondary sensing eliminates delays, tames large-signal overshoot and reduces output capacitance while utilizing off-the-shelf magnetics and attaining high efficiency.

For large values of input inductance, a 100V, 47uF electrolytic capacitor can be added across the input terminals to damp the input filter and provide adequate stability. See Linear Technology Application Note AN19 for a discussion on input filter stability analysis. A recommended part is the Sanyo 100MV39AX.

QUICK START PROCEDURE

Demonstration circuit 1031A-A is easy to set up to evaluate the performance of the LTC3725/LTC3726. Refer to Figure 1 for proper measurement equipment setup and follow the procedure below:

NOTE: When measuring the input or output voltage ripple, care must be taken to avoid a long ground lead on the oscilloscope probe. Measure the output (or input) voltage ripple by touching the probe tip and probe ground directly across the input or output capacitor. See Figure 2 for proper scope probe technique.

1. Set an input power supply that is capable of 36V to 72V at a current of at least 2A to a voltage of 36V. Then, turn off the supply.
2. With power off, connect the supply to the input terminals +Vin and -Vin.
 - a. Input voltages lower than 36V can keep the converter from turning on due to the undervoltage lockout feature of the LTC3725/LTC3726.
 - b. If efficiency measurements are desired, an ammeter capable of measuring 2A_{dc} can be put in series with the input supply in order to measure the DC1031A-A's input current.
 - c. A voltmeter with a capability of measuring at least 72V can be placed across the input terminals in order to get an accurate input voltage measurement.
3. Turn on the power at the input.

NOTE: Make sure that the input voltage never exceeds 72V.
4. Check for the proper output voltage of 2.5V
5. Turn off the power at the input.
6. Once the proper output voltages are established, connect a variable load capable of sinking 20A at 2.5V to the output terminals +Vout and -Vout. Set the current for 0A.
 - a. If efficiency measurements are desired, an ammeter or a resistor current shunt that is capable of handling at least 20A_{dc} can be put in series with the output load in order to measure the DC1031A-A's output current.
 - b. A voltmeter with a capability of measuring at least 2.5V can be placed across the output terminals in order to get an accurate output voltage measurement.
7. Turn on the power at the input.

NOTE: If there is no output, temporarily disconnect the load to make sure that the load is not set too high.
8. Once the proper output voltage is established, adjust the load within the operating range and observe the output voltage regulation, ripple voltage, efficiency and other desired parameters.

QUICK START GUIDE FOR DEMONSTRATION CIRCUIT 1031A-A

36V-72VIN, SYNCHRONOUS FORWARD CONVERTER

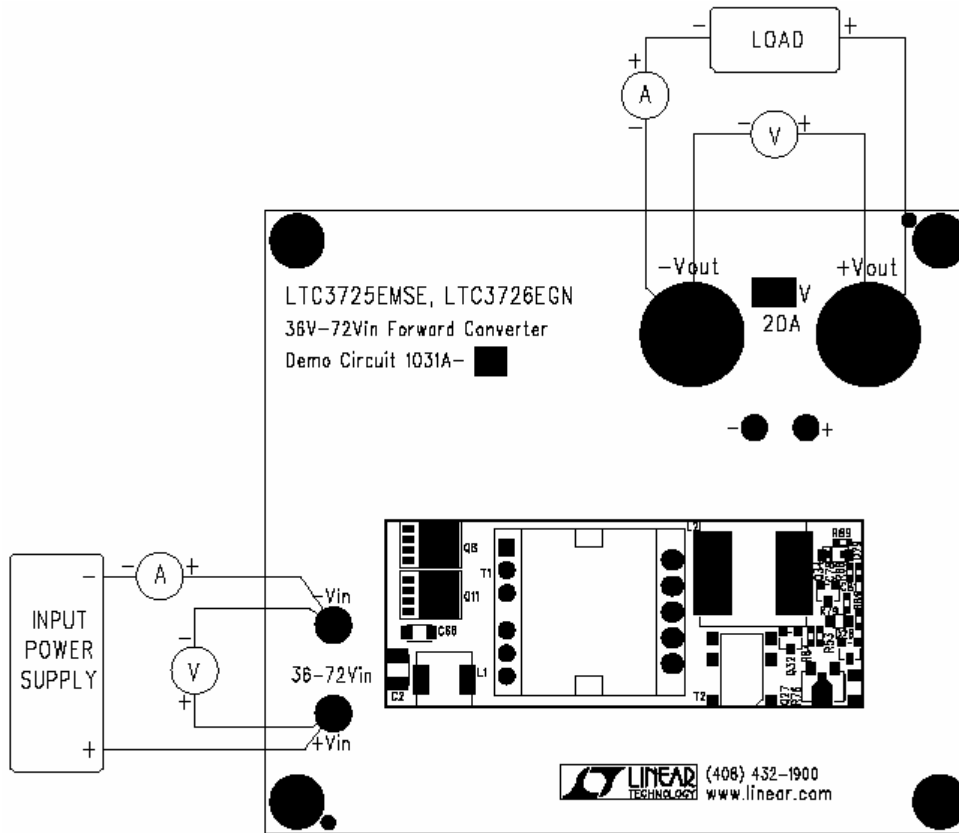

Figure 1. Proper Measurement Equipment Setup

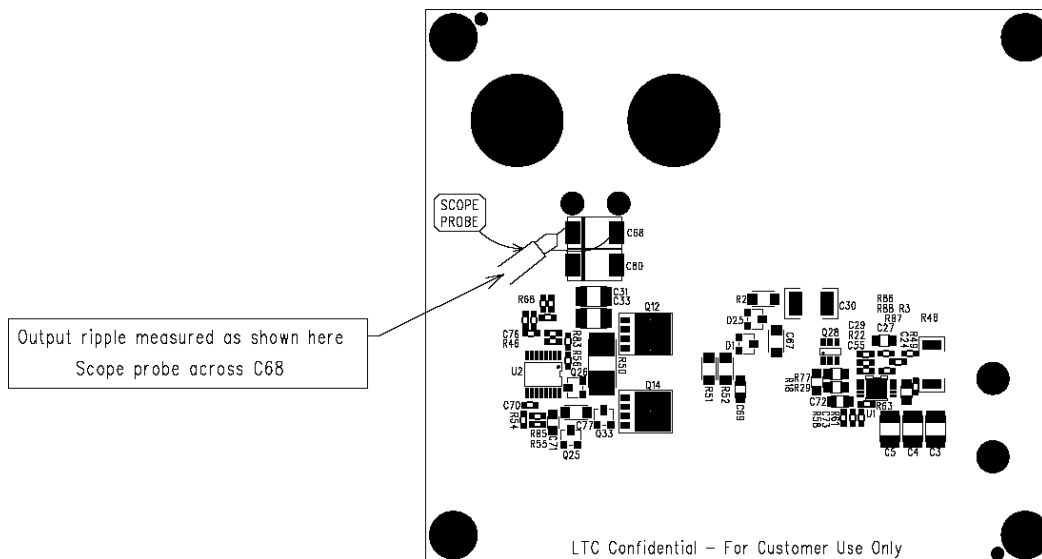

Figure 2. Measuring Input or Output Ripple

MEASURED DATA

Figures 3 through 11 are measured data for a typical DC1031A-A. Figures 12 through 21 are schematics, bill of materials and layout.

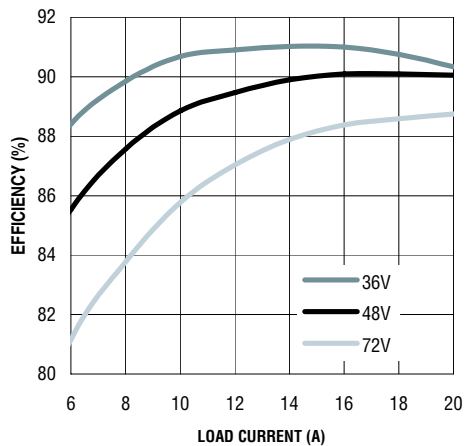

Figure 3. Efficiency (200lfm airflow)

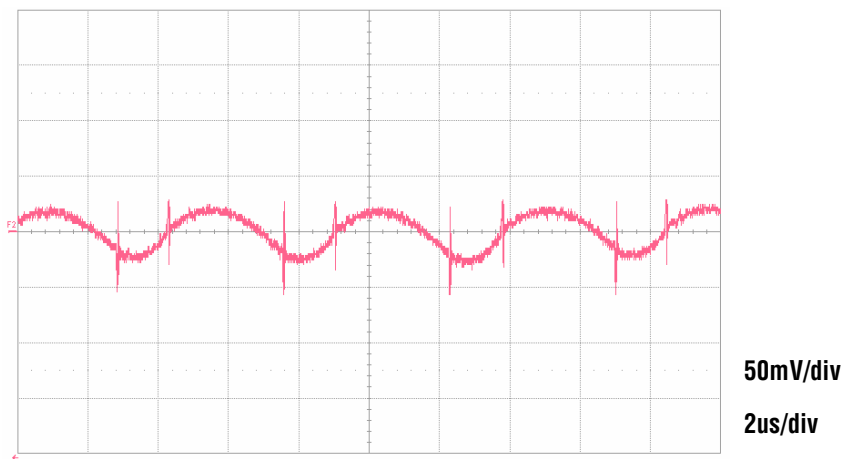

Figure 4. Output Ripple Voltage (72Vin, 20Aout)

QUICK START GUIDE FOR DEMONSTRATION CIRCUIT 1031A-A

36V-72VIN, SYNCHRONOUS FORWARD CONVERTER

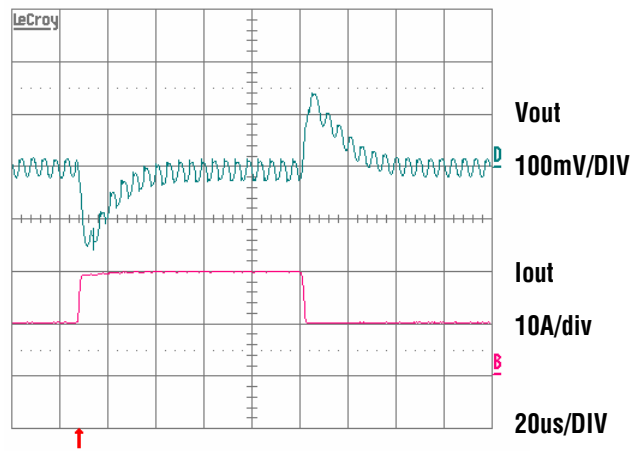

Figure 5. Output Voltage Transient Response (48Vin, 10A to 20A step)

QUICK START GUIDE FOR DEMONSTRATION CIRCUIT 1031A-A 36V-72VIN, SYNCHRONOUS FORWARD CONVERTER



Figure 6. Temp Data (48Vin, 20A, 25°C, 200LFM airflow – front)

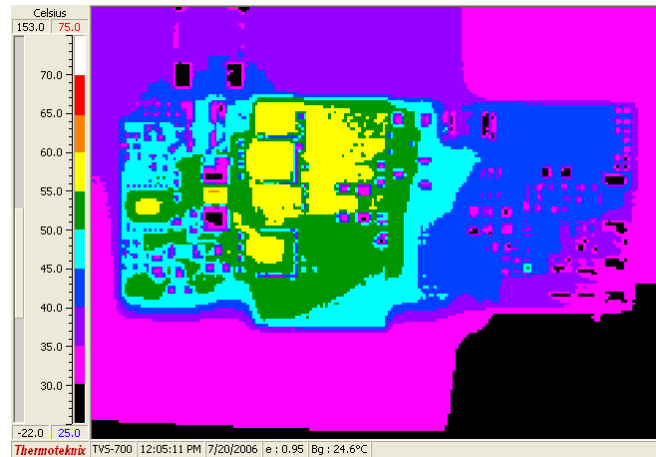

Figure 7. Temp Data (48Vin, 20A, 25°C, 200LFM airflow – back)



Figure 8. Temp Data (36Vin, 20A, 25°C, 200LFM airflow – front)

QUICK START GUIDE FOR DEMONSTRATION CIRCUIT 1031A-A 36V-72VIN, SYNCHRONOUS FORWARD CONVERTER

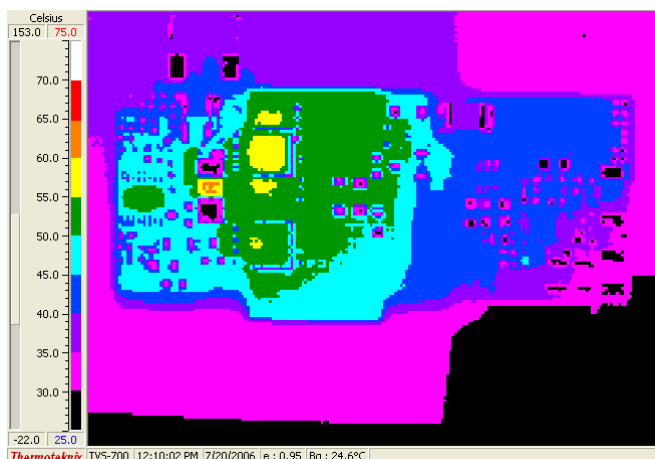

Figure 9. Temp Data (36Vin, 20A, 25°C, 200LFM airflow – back)

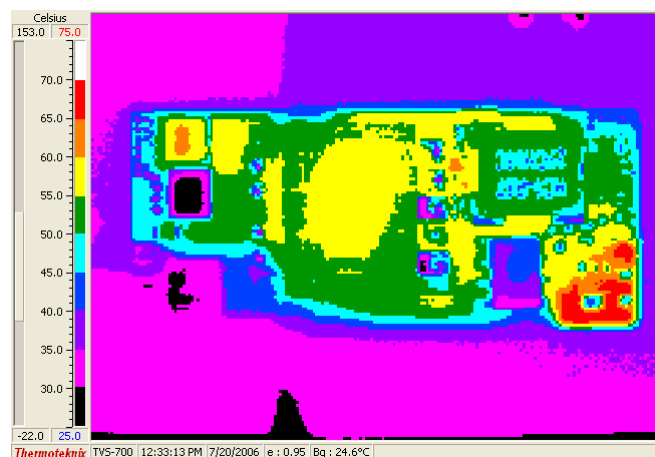

Figure 10. Temp Data (72Vin, 20A, 25°C, 200LFM airflow – front)

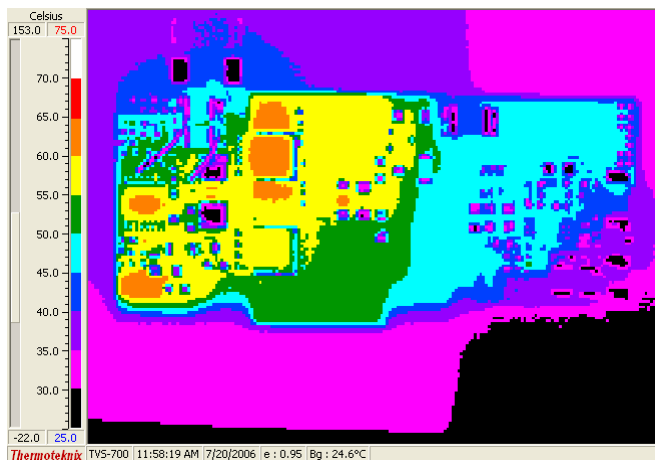
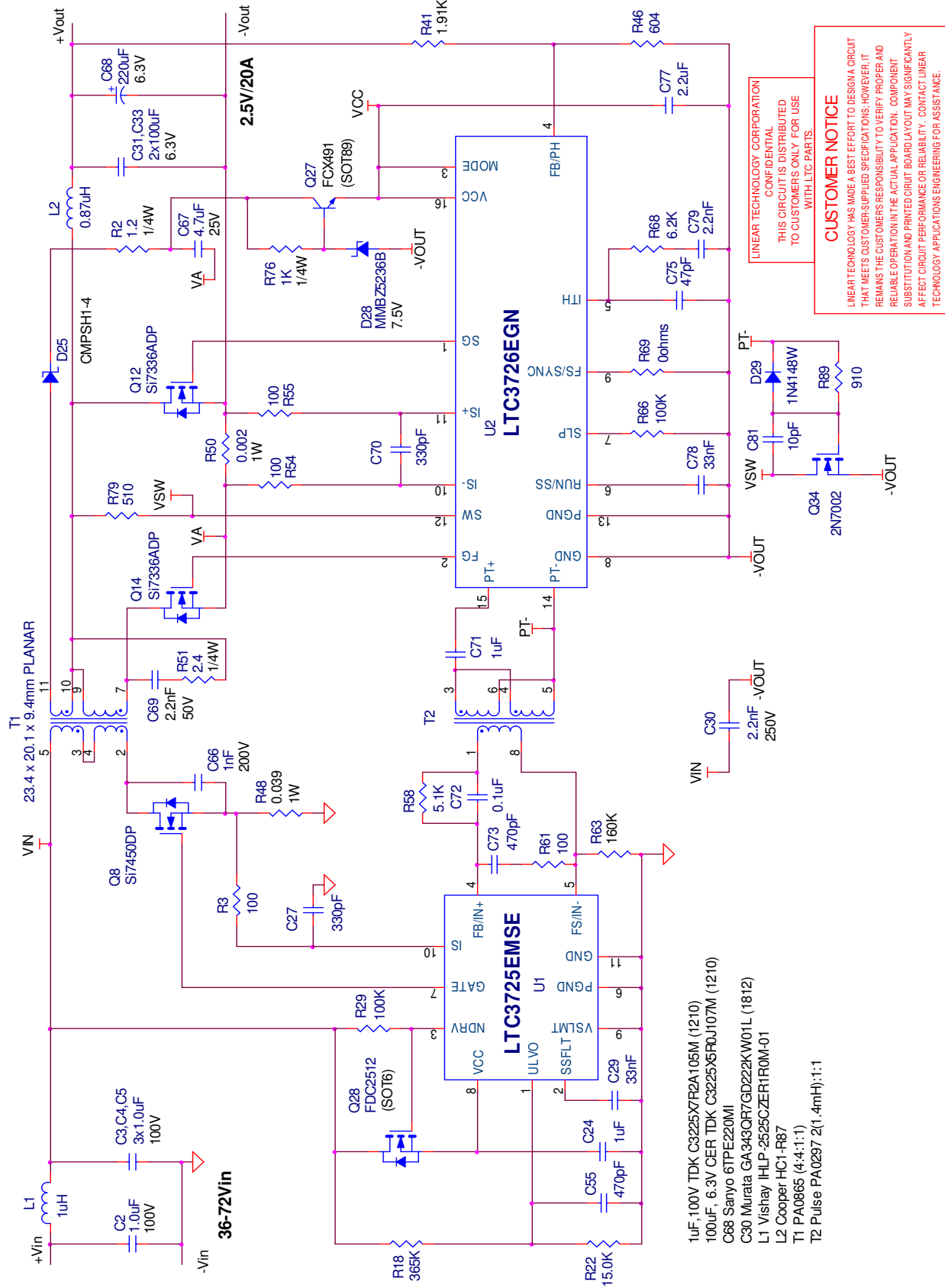

Figure 11. Temp Data (72Vin, 20A, 25°C, 200LFM airflow – back)

QUICK START GUIDE FOR DEMONSTRATION CIRCUIT 1031A-A

36V-72VIN, SYNCHRONOUS FORWARD CONVERTER



- 1µF, 100V TDK C3225X7R2A105M (1210)
- 100µF, 6.3V CER TDK C3225X5FRU107M (1210)
- C68 Sanyo 6TPE220M1
- C30 Murata GA34QR7GD222K W01L (1812)
- L1 Vishay IHLP-2525CZER1R0M-01
- L2 Cooper HC1-R87
- T1 PA0865 (4:4:1:1)
- T2 Pulse PA0297 2(1.4mH):1:1

Figure 12. Simplified Schematic

QUICK START GUIDE FOR DEMONSTRATION CIRCUIT 1031A-A

36V-72VIN, SYNCHRONOUS FORWARD CONVERTER

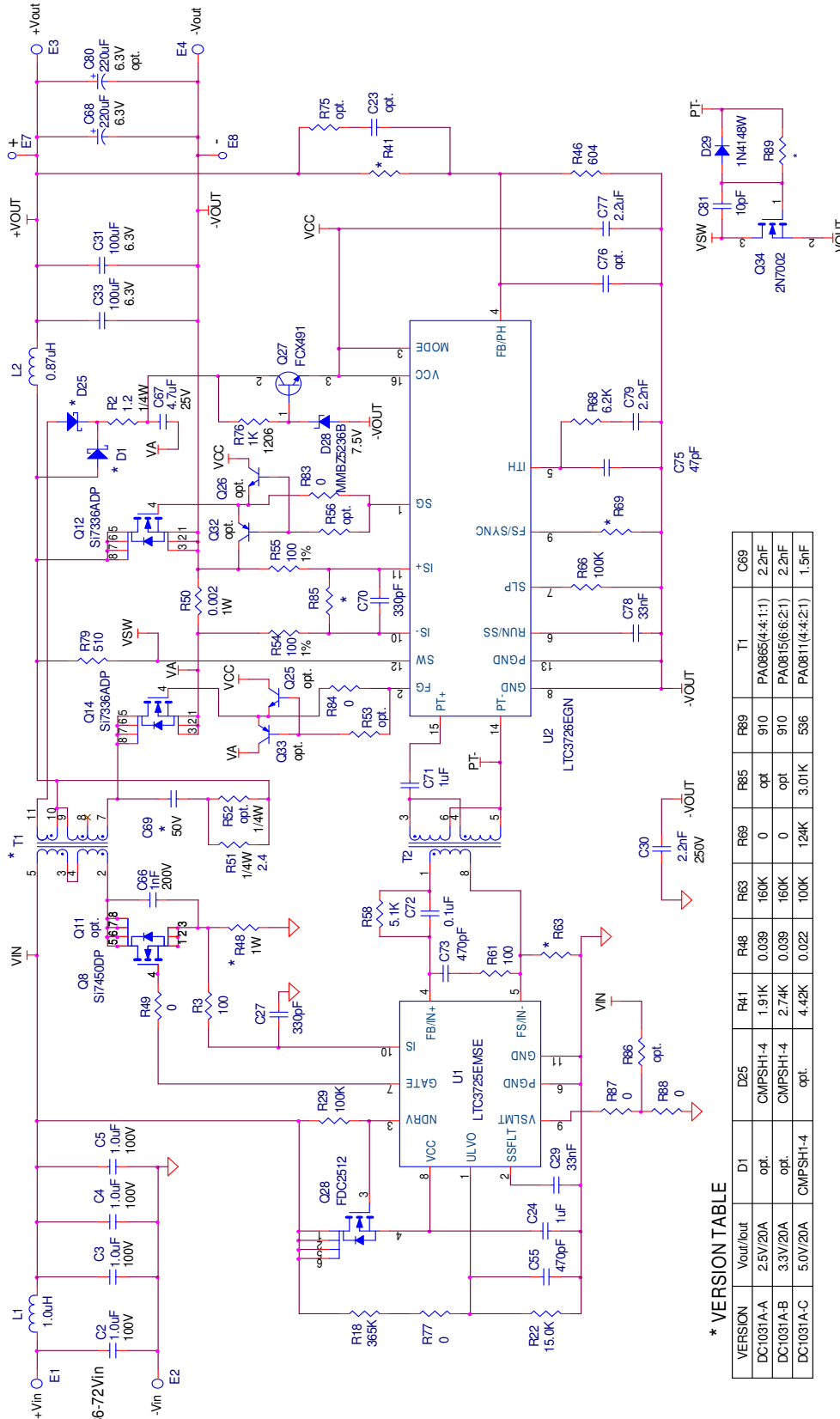

* VERSION TABLE

VERSION	Vout/Iout	D1	D25	R41	R48	R63	R69	R85	R89	T1	C69
DC:1031A-A	2.5V/20A	opt.	CMPSSH1-4	1.91K	0.039	160K	0	opt.	910	PA0865(4:4:1:1)	2.2nF
DC:1031A-B	3.3V/20A	opt.	CMPSSH1-4	2.74K	0.039	160K	0	opt.	910	PA0815(6:6:2:1)	2.2nF
DC:1031A-C	5.0V/20A	opt.	CMPSSH1-4	4.42K	0.022	100K	124K	3.01K	536	PA0811(4:4:2:1)	1.5nF

For All The Versions
 C2-C5 1uF, 100V TDK C3225XFR2A105M (1210)
 C31-C33 100uF, 6.3V CER TDK C3225XFRQ107M (1210)
 C68 Sanyo 6TPE220M1
 L1 Vishay, HL P-2625CZER1R0M-01 or
 COOPER HCP0703-1R0R
 L2 Coil Tronics HCl-F87
 T2 Pulse PA0297 2(1.4mH):1:1

CUSTOMER NOTICE
 LINEAR TECHNOLOGY HAS MADE A BEST EFFORT TO DESIGN A CIRCUIT THAT MEETS CUSTOMER-SUPPLIED SPECIFICATIONS; HOWEVER, IT REMAINS THE CUSTOMER'S RESPONSIBILITY TO VERIFY PROPER AND RELIABLE OPERATION IN THE ACTUAL APPLICATION. COMPONENT SUBSTITUTION AND PRINTED CIRCUIT BOARD LAYOUT MAY SIGNIFICANTLY AFFECT CIRCUIT PERFORMANCE OR RELIABILITY. CONTACT LINEAR TECHNOLOGY FOR ASSISTANCE.
 THIS CIRCUIT IS PROPRIETARY TO LINEAR TECHNOLOGY AND SUPPLIED FOR USE WITH LINEAR TECHNOLOGY PARTS.

CONTRACT NO. _____
 APPROVALS DATE 12/5/05
 DRAWN J. WU
 CHECKED _____
 APPROVED _____
 ENGINEER K. Mathews
 DESIGNER _____

DATE 12/5/05
 TITLE LTC3725EMSE, LTC3726EGN, 36V - 72Vin Forward Converter
 SIZE (CAGE CODE) DWGNO DC:1031A
 SCALE FLEMAME SHEET 1 OF 1

Figure 13. Full Board Schematic

QUICK START GUIDE FOR DEMONSTRATION CIRCUIT 1031A-A

36V-72VIN, SYNCHRONOUS FORWARD CONVERTER

Item	Qty	Reference	Part Description	Manufacture / Part #
REQUIRED CIRCUIT COMPONENTS'				
1	4	C2,C3,C4,C5	CAP., X7R, 1.0uF, 100V, 20%, 1210	TDK, C3225X7R2A105M
2	2	C71,C24	CAP., X7R, 1uF, 16V 10%, 0805	TAIYO YUDEN, EMK212BJ105KG
3	2	C27,C70	CAP., X7R, 330pF, 25V, 10%, 0603	AVX, 06033C331KAT2A
4	2	C29,C78	CAP., X7R, 33nF, 25V, 10%, 0603	AVX, 06033C333KAT2A
5	1	C30	CAP., X7R, 2.2nF, 250V, 10%, 1812	MURATA, GA343QR7GD222KW01L
6	2	C31,C33	CAP., X5R, 100uF, 6.3V, 20%, 1210	TDK, C3225X5R0J107M
7	2	C73,C55	CAP., COG, 470pF, 25V, 10%, 0603	AVX, 06033A471KAT2A
8	1	C66	CAP., COG, 1nF, 200V, 10%, 1206	AVX, 12062A102KAT2A
9	1	C67	CAP., X7R, 4.7uF, 25V, 20%, 1206	TDK, C3216X7R1E475M
10	1	C68	CAP., POSCAP, 220uF, 6.3V, 20% 7343	SANYO, 6TPE220MI
11	1	C69	CAP., NPO, 2.2nF, 50V, 10%, 0805	AVX, 08055A222KAT2A
12	1	C72	CAP., X7R, 0.1uF, 25V, 10%, 0805	AVX, 08053C104KAT2A
13	1	C75	CAP., NPO, 47pF, 25V, 10%, 0603	AVX, 06033A470KAT2A
14	1	C77	CAP., X7R, 2.2uF, 16V, 20%, 1206	TDK, C3216X7R1C225M
15	1	C79	CAP., X7R, 2.2nF, 25V, 10%, 0603	AVX, 06033C222KAT2A
16	1	C81	CAP., COG, 10pF, 50V, 5%, 0603	AVX, 06035A100JAT2A
17	1	D25	DIODE, Schottky, CMPSH1-4, 40V, SOT23	CENTRAL SEMI., CMPSH1-4-LTC
18	1	D28	Diode, MMBZ5236B, SOT23	DIODES INC., MMBZ5236B-7
19	1	D29	Diode, 1N4148W SOD-123	DIODES INC., 1N4148W-7-F
20	1	L1	INDUCTOR, 1.0uH	VISHAY DALE, IHLP2525CZER1R0M01
	0	L1 (second source)	INDUCTOR, 1.0uH	COOPER, HCP0703-1R0-R
21	1	L2	INDUCTOR, 0.87uH	COOPER, HC1-R87
22	1	Q8	FET, N-CH., Si7450DP, POWERPAK SO-8	VISHAY, Si7450DP
23	2	Q12,Q14	FET, N-CH., Si7336ADP, POWERPAK SO-8	VISHAY, Si7336ADP
24	1	Q34	N-CH., Transistor. 2N7002 SOT23	DIODES INC., 2N7002-7-F
25	1	Q27	NPN TRANSISTOR, FCX491	ZETEX, FCX491
26	1	Q28	N-CH FET, 150V, FDC2512, Super SOT-6	FAIRCHILD, FDC2512
27	1	R2	RES., CHIP, 1.2, 1/4W, 5%, 1206	AAC, CR18-1R2JM
28	2	R54,R55	RES., CHIP, 100, 1/16W, 1%, 0603	VISHAY, CRCW06031000FRT6
29	1	R18	RES., CHIP, 365K, 1/8W, 1%, 0805	VISHAY, CRCW0805365KFKEB
30	1	R22	RES., CHIP, 15.0K, 1/16W, 1%, 0603	AAC, CR16-1502FM
31	1	R29	RES., CHIP, 100K, 1/8W, 5%, 0805	AAC, CR10-104JM
32	1	R41	RES., CHIP, 1.91K, 1/16W, 1%, 0603	AAC, CR16-1911FM
33	1	R46	RES., CHIP, 604, 1/16W, 1%, 0603	AAC, CR16-6040FM
34	1	R48	RES., CHIP, 0.039, 1W, 2%, 2010	IRC, LRC-LR2010-01-R039-G
35	1	R50	RES., CHIP, 0.002, 1W, 1%, 2512	PANASONIC, ERJM1WTF2M0U
36	1	R51	RES., CHIP, 2.4, 1/4W, 5%, 1206	AAC, CR18-2R4JM
37	1	R58	RES., CHIP, 5.1K, 1/16W, 5%, 0603	AAC, CR16-512JM
38	2	R3,R61	RES., CHIP, 100, 1/16W, 5%, 0603	AAC, CR16-101JM
39	1	R63	RES., CHIP, 160K, 1/16W, 5%, 0603	AAC, CR16-164JM
40	1	R66	RES., CHIP, 100K, 1/16W, 5%, 0603	AAC, CR16-104JM
41	1	R68	RES., CHIP, 6.2K, 1/16W, 5%, 0603	AAC, CR16-622JM
42	1	R69	RES., CHIP, 0, 1/16W, 0603	Panasonic, ERJ3GEY0R00V
43	1	R76	RES., CHIP, 1K, 1/4W, 5%, 1206	AAC, CR18-102JM
44	1	R79	RES., CHIP, 510, 1/8W, 5%, 0805 e3	AAC, CR10-511JM

QUICK START GUIDE FOR DEMONSTRATION CIRCUIT 1031A-A

36V-72VIN, SYNCHRONOUS FORWARD CONVERTER

45	1	R89	RES., CHIP, 910, 1/16W, 5%, 0603 e3	VISHAY, CRCW0603910RJNEA
46	1	T1	TRANSFORMER, 1750VDC BASIC, PA0865	PULSE, PA0865
47	1	T2	TRANSFORMER, 1500VRMS BASIC, PA0297	PULSE, PA0297
48	1	U1	I.C., LTC3725EMSE, MS10E	LINEAR TECH., LTC3725EMSE
49	1	U2	I.C., LTC3726EGN, SSOP16GN	LINEAR TECH., LTC3726EGN
ADDITIONAL DEMO BOARD CIRCUIT COMPONENTS²				
1	0	C23,C76 (opt.)	CAP., 0603	
2	0	C80 (opt.)	CAP., POSCAP, 220uF, 6.3V, 20% 7343	
3	0	D1 (opt.)	DIODE, Schottky, CMPSH1-4, 40V, SOT23	
4	0	Q11 (opt.)	FET, N-CH, POWERPAK SO-8	
5	0	Q25,Q26 (opt.)	NPN Transistor, FMMT619, SOT23	
6	0	Q32,Q33 (opt.)	PNP Transistor, FMMT718, SOT23	
7	5	R49,R83,R84,R87,R88	RES., CHIP, 0, 1/16W, 0603	Panasonic, ERJ3GEY0R00V
8	0	R52 (opt.)	RES., CHIP, 1206	
9	0	R53,R56,R75,R85 (opt.)	RES., CHIP, 0603	
11	1	R77	RES., CHIP, 0, 1/8W, 0805	AAC, CJ10-000M
12	0	R86 (opt.)	RES., CHIP, 0805	
HARDWARE-FOR DEMO BOARD ONLY:				
1	2	E1,E2	TESTPOINT, TURRET, .094"	MILL-MAX, 2501-2
2	2	E3,E4	STUD	PEM, KFH-032-10
3	4	E3,E4 (2 EACH)	NUT, BRASS, #10-32	ANY
4	2	E3,E4	Ring, Lug Ring # 10	KEYSTONE 8205
5	2	E3,E4	WASHER, STAR #10 BRASS NICHEL	ANY
6	2	E8,E7	TURRET,	MILL-MAX2308-2-00-44
7	4	(STAND-OFF)	STAND-OFF, NYLON 0.50"	KEYSTONE 8833 (SNAP ON)
Notes:				
1. Required Circuit Components are those parts that are required to implement the circuit function				
2. Additional Demo Board Circuit Components are those parts that provide added functionality for the demo board but are not required in the actual circuit.				

Figure 14. Bill of Materials

QUICK START GUIDE FOR DEMONSTRATION CIRCUIT 1031A-A
 36V-72VIN, SYNCHRONOUS FORWARD CONVERTER

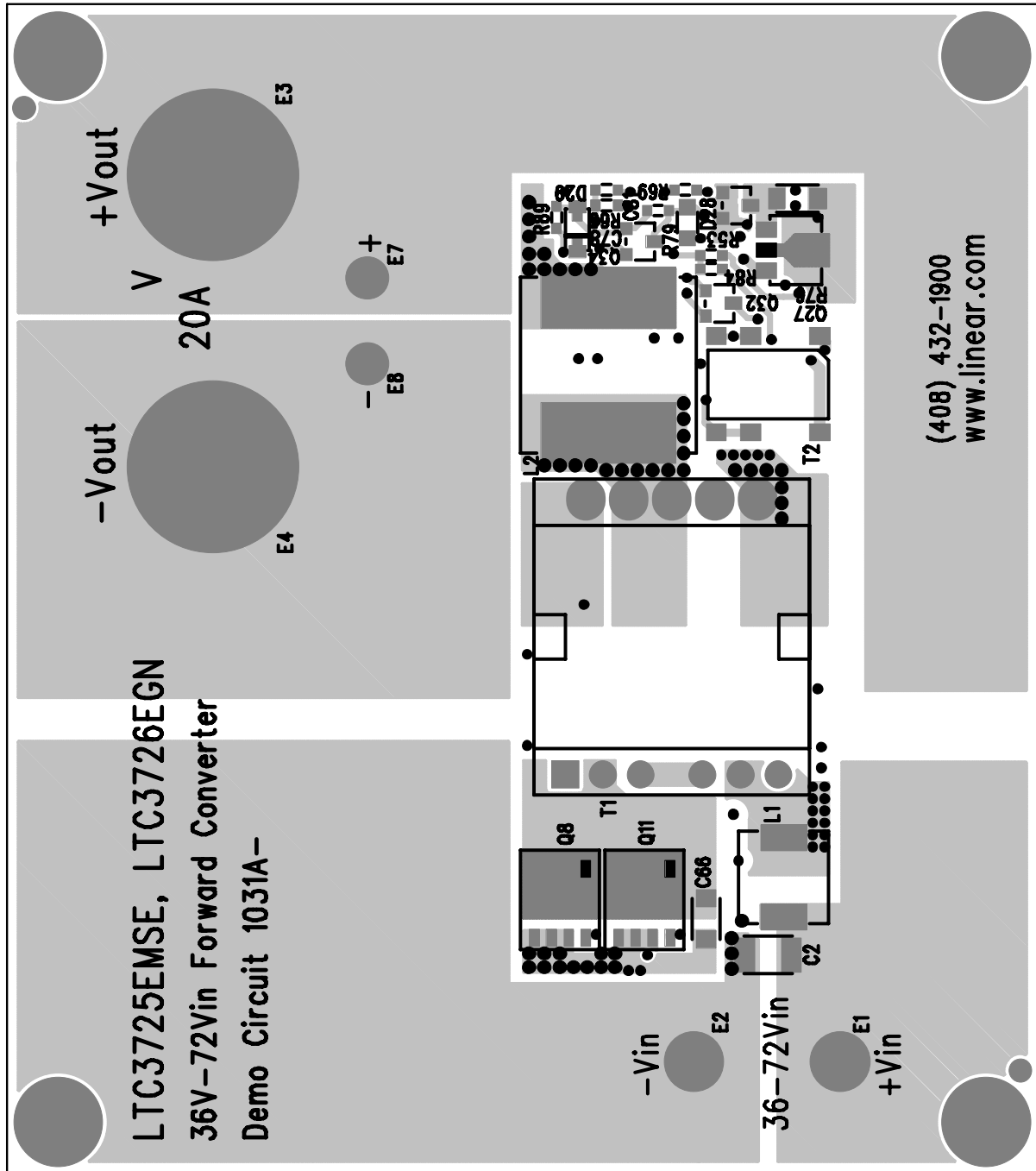

Figure 15. Top

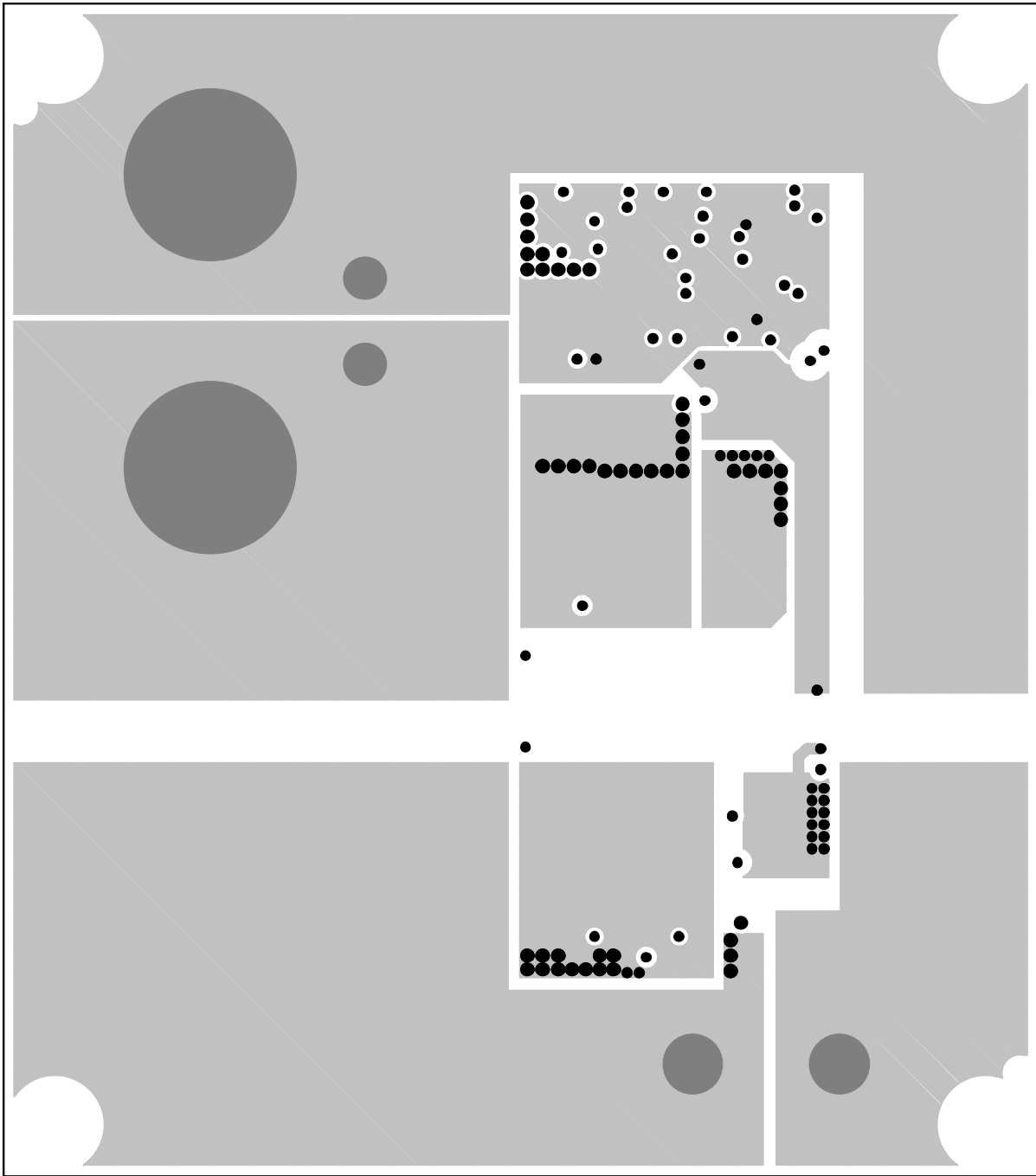

Figure 16. Layer 2

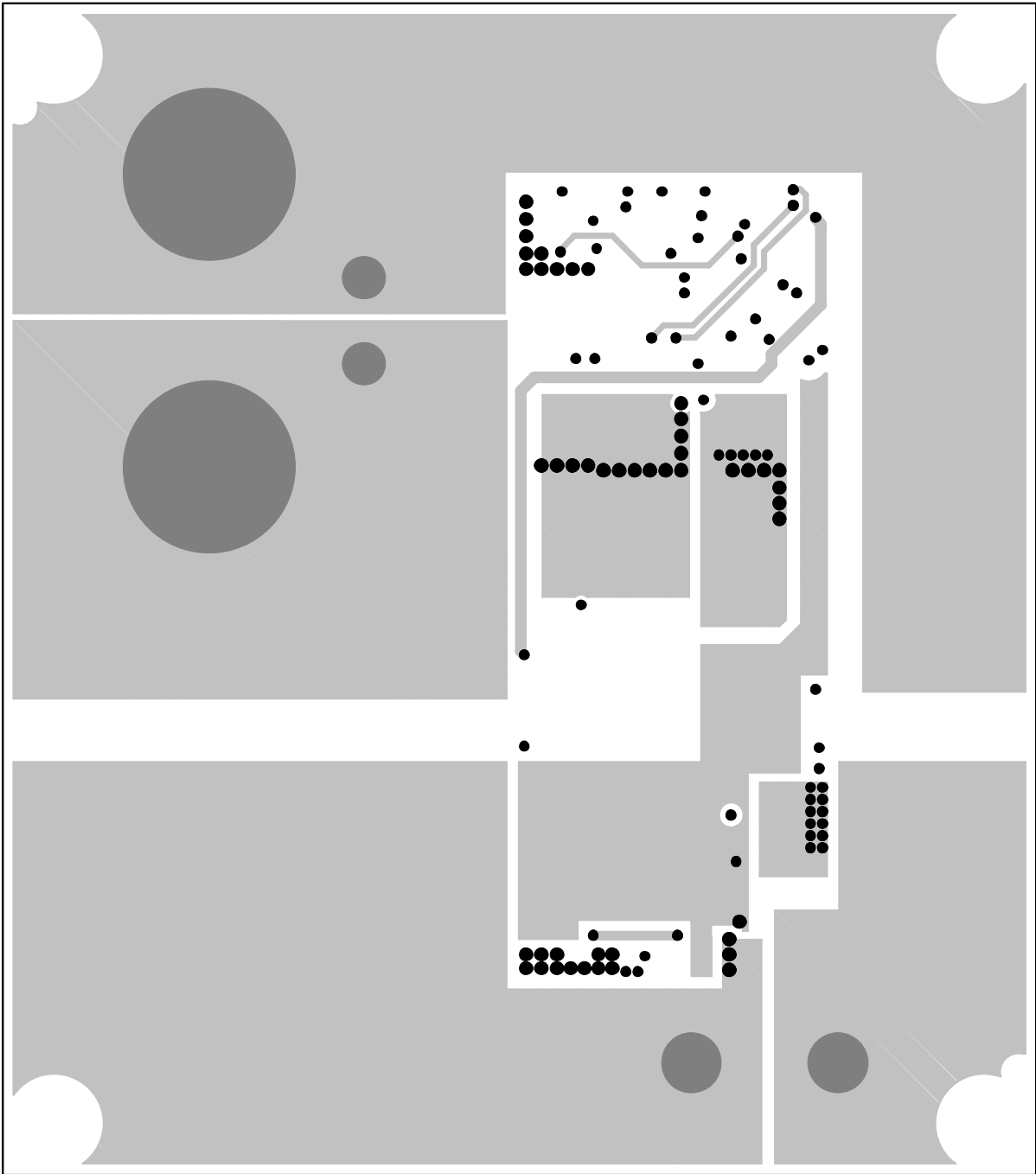

Figure 17. Layer 3

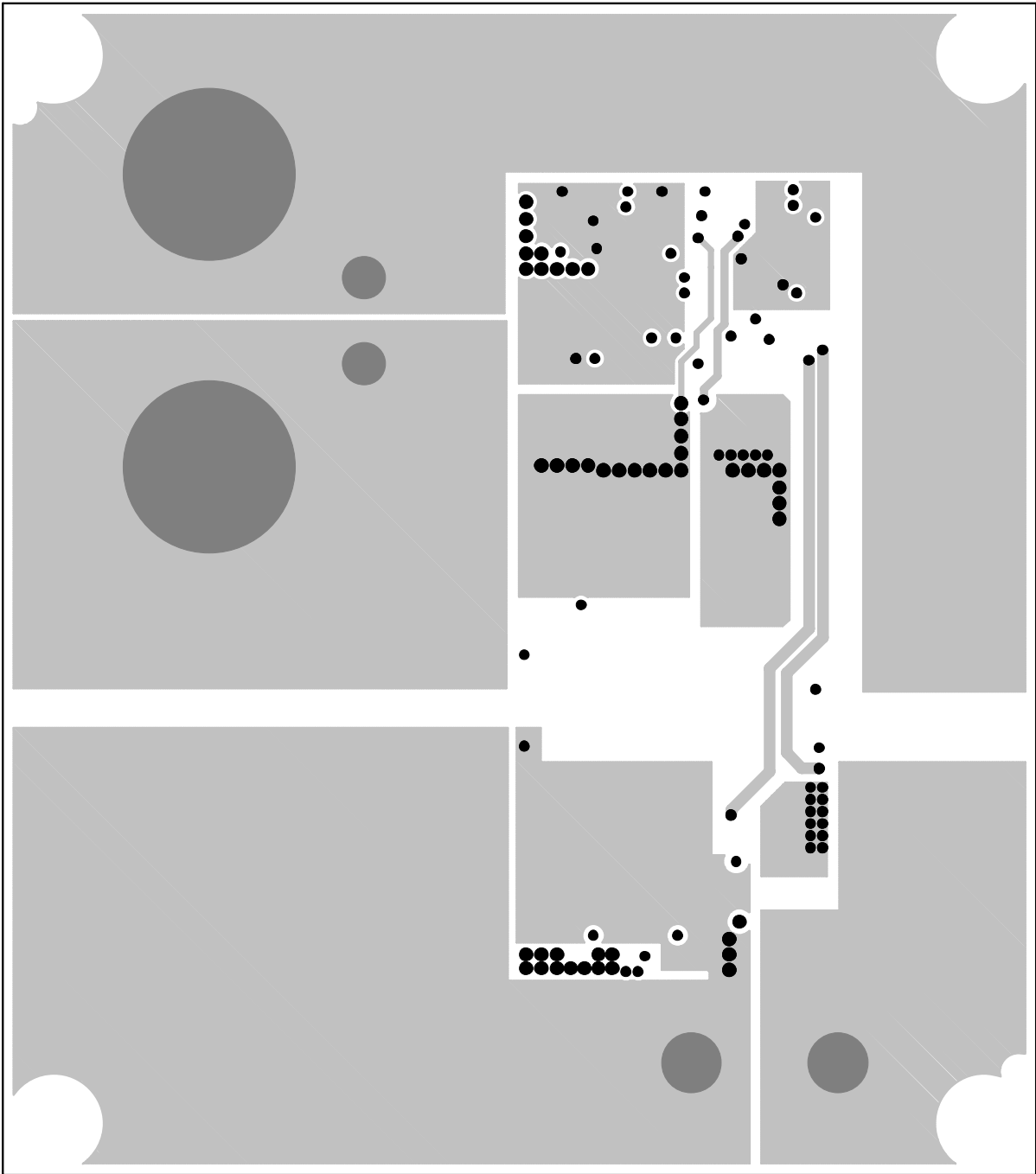

Figure 18. Layer 4



Figure 19. Layer 5

QUICK START GUIDE FOR DEMONSTRATION CIRCUIT 1031A-A

36V-72VIN, SYNCHRONOUS FORWARD CONVERTER

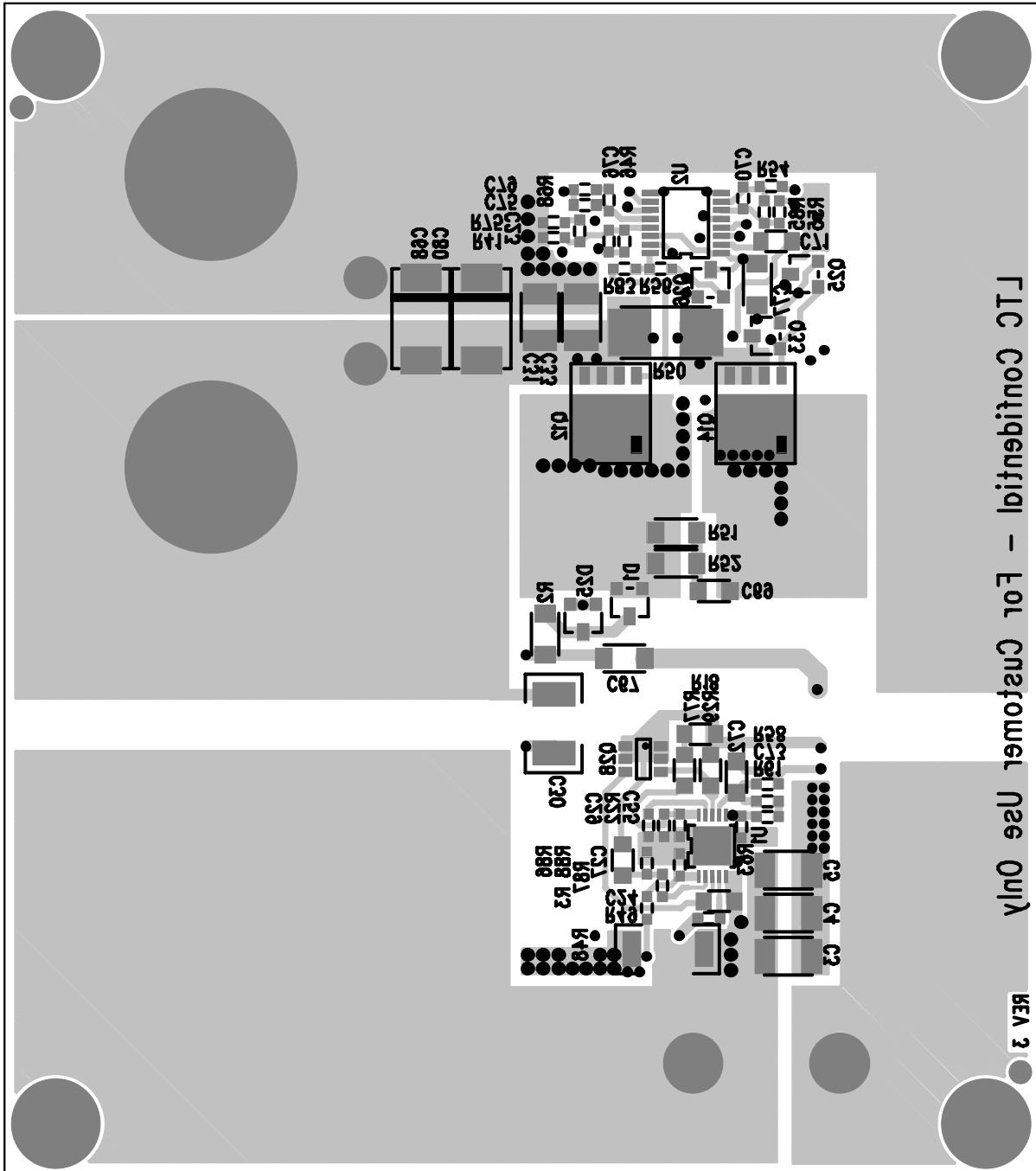

Figure 20. Bottom

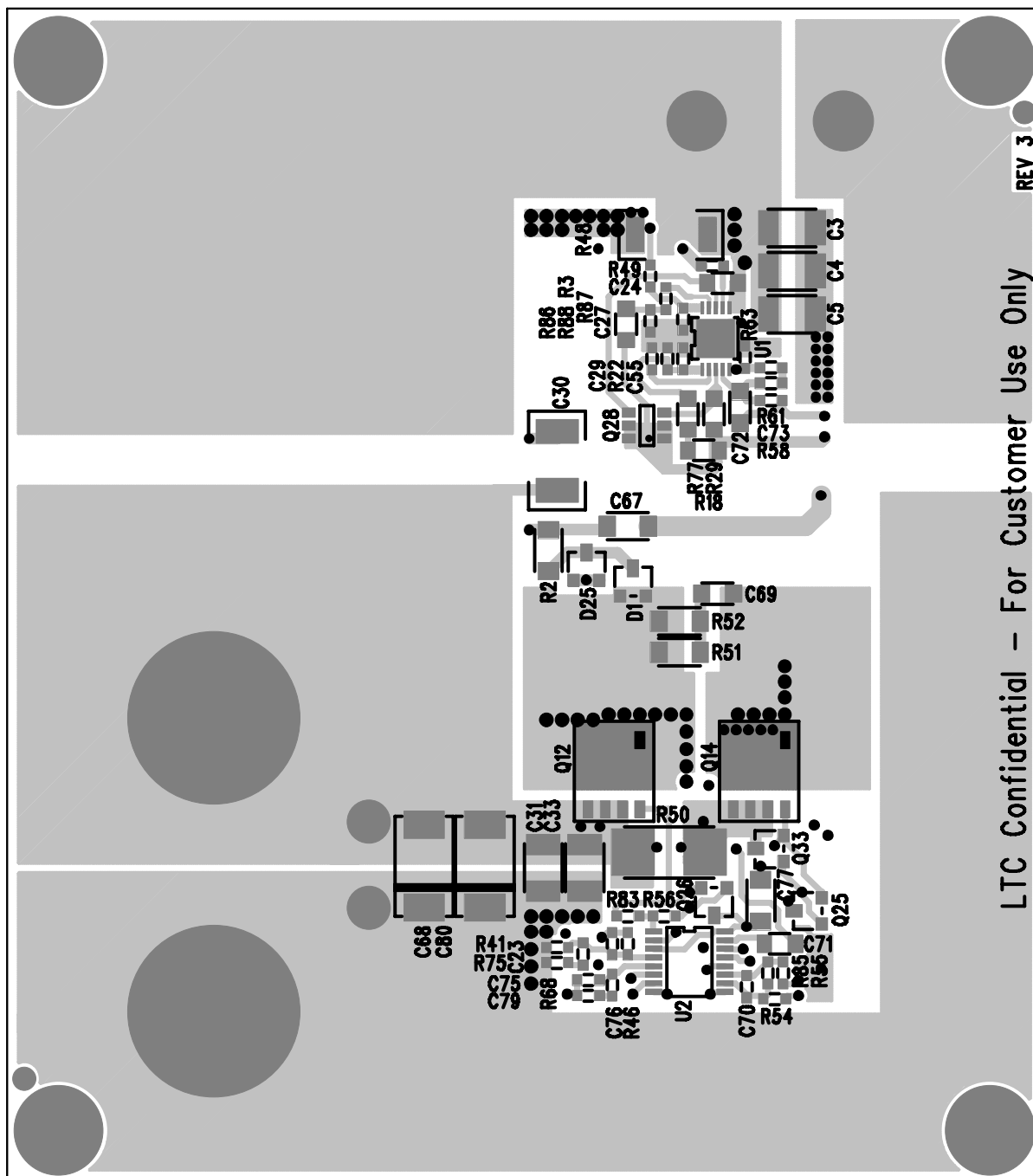

Figure 21. Bottom Mirrored