



PART NAME

EXTRUDED ALUMINUM IP65 PCB ENCLOSURES

PART No.

EXN-23365 (SEE TABULATION FOR COMBINATIONS)

REVISION DATE

10-23-15

PART NUMBER	ALUM. COVER	PLASTIC COVER	BODY COLOR
EXN-23365-BK	BLACK	-	BLACK
EXN-23365-BKP	-	BLACK	BLACK
EXN-23365-BL	BLACK	-	BLUE
EXN-23365-BLP	-	TRANSLUCENT BLUE	BLUE
EXN-23365-GD	BLACK	-	GOLD
EXN-23365-GDP	-	CLEAR	GOLD
EXN-23365-RD	BLACK	-	RED
EXN-23365-RDP	-	IR RED	RED
EXN-23365-SV	BLACK	-	SILVER
EXN-23365-SVP	-	CLEAR	SILVER

MATERIAL: ALUMINUM EXTRUSION BODY PROVIDED WITH ALUMINUM COVER (2X) AND GASKETS OR POLYCARBONATE COVER (2X) AND GASKETS - NOT ASSEMBLED

DIMENSIONS ARE INCH[MM]

DRAWING FOR REFERENCE
WE RESERVE THE RIGHT TO MAKE CHANGES TO OUR STANDARD PRODUCTS. PLEASE CONSULT WITH BUD INDUSTRIES PRIOR TO USING THIS DRAWING FOR DESIGN PURPOSE.

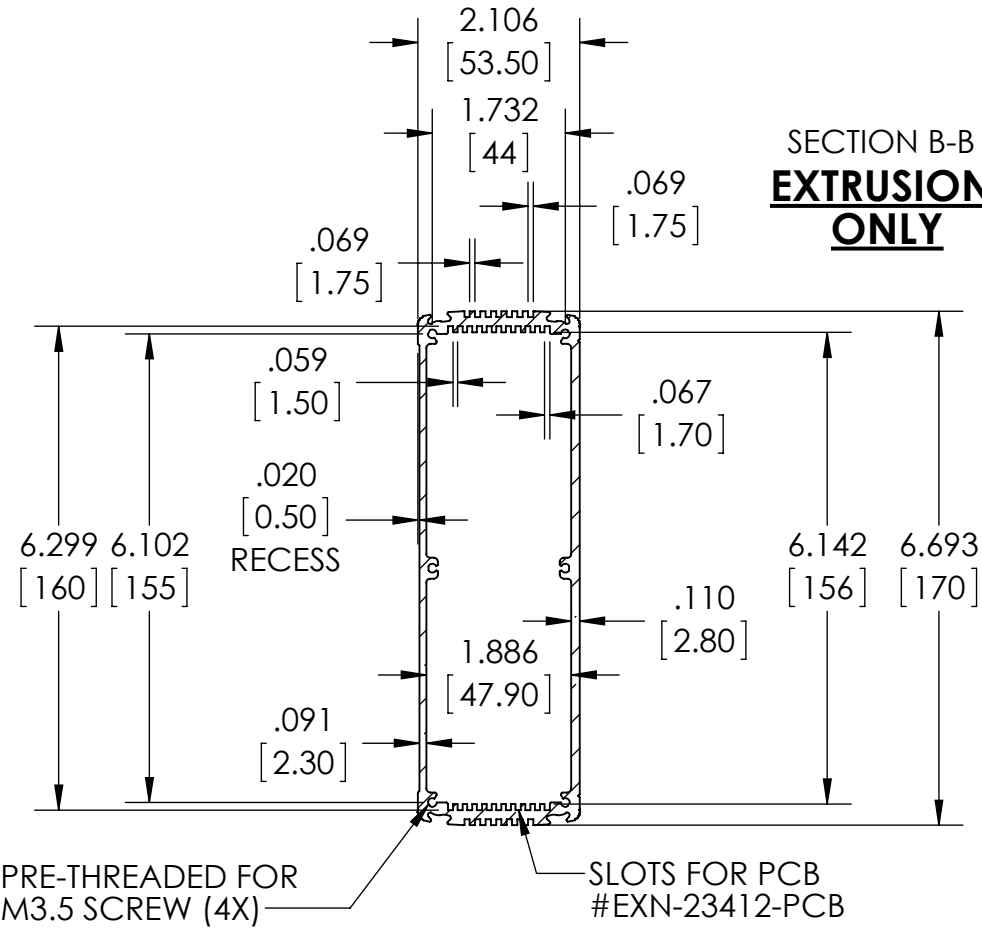
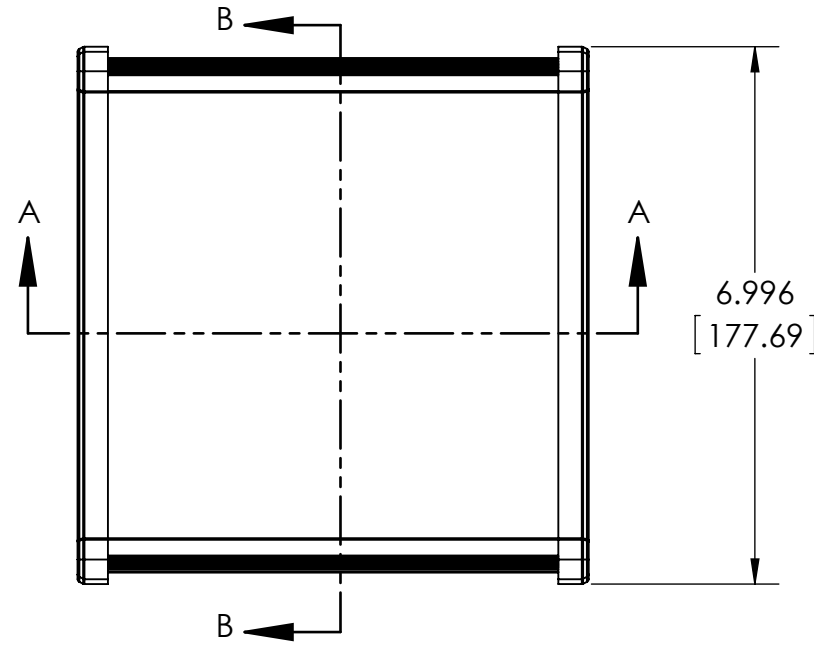
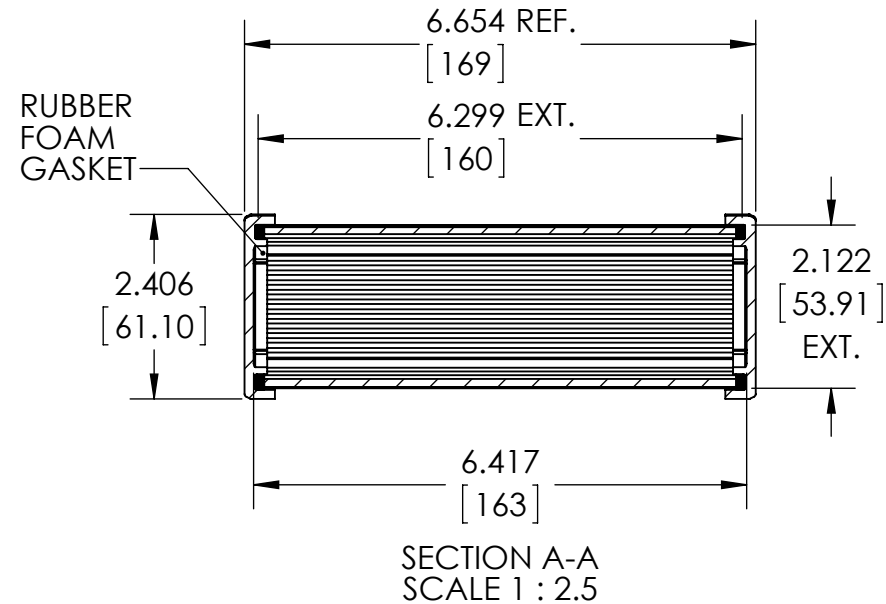
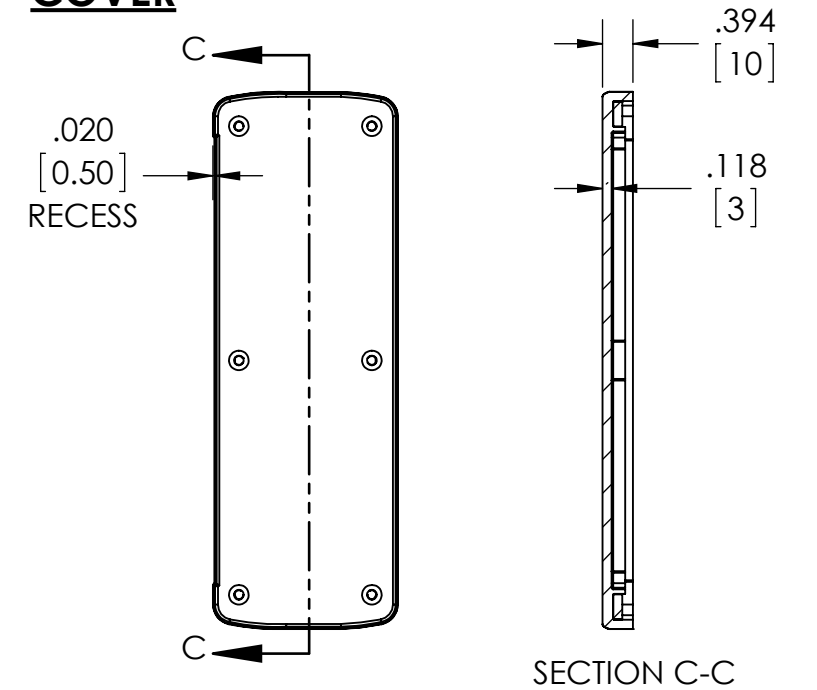
**DIE CAST ALUMINUM COVER**

DIMENSIONS MAY VARY DEPENDING ON THE COMPRESSION OF THE GASKETS

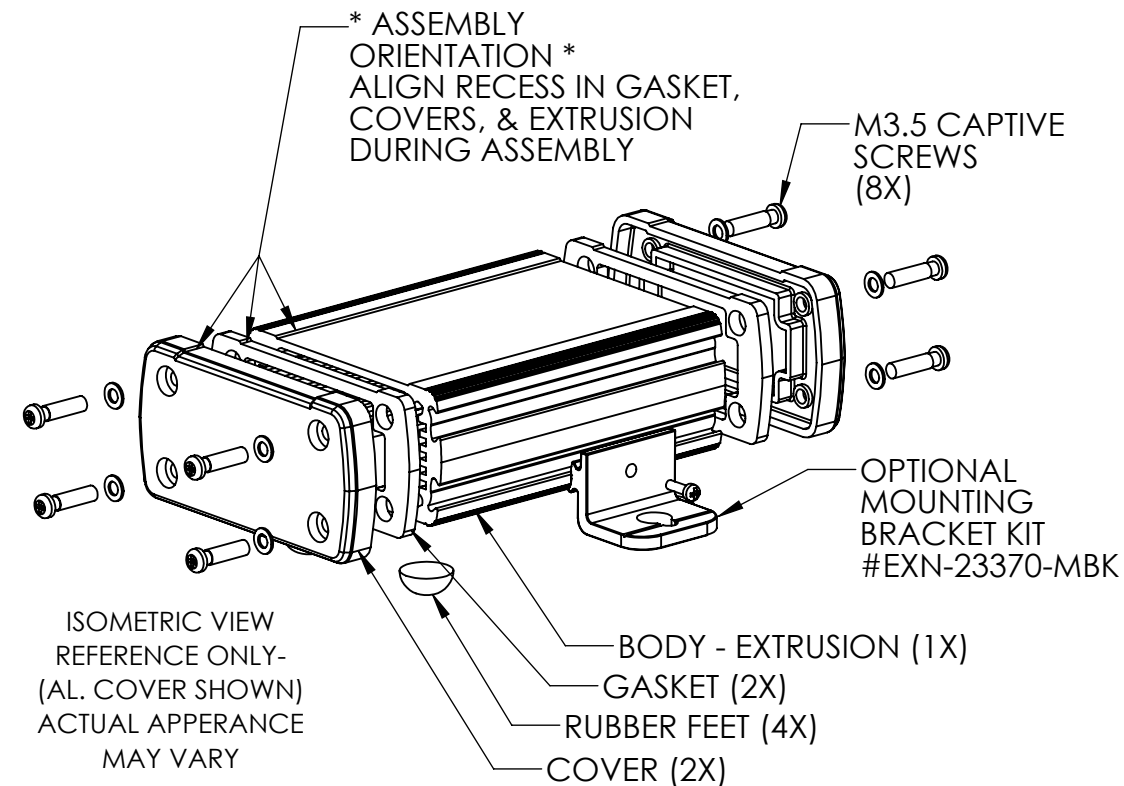
**PLASTIC COVER**