

Electronic fuses

Section Contents

	Page
5 x 15mm ferrule fuses	58
5 x 20mm European (IEC) ferrule fuses	59-60
5 x 20mm North American (UL) ferrule fuses	61
¼" Dia. x ½" to 1" length ferrule fuses	62
¼" Dia. x 1 ¼" length fast-acting ferrule fuses	63
¼" Dia. x 1 ¼" length time-delay ferrule fuses	64
PCB mount fuse holders	65-66
PCB fuseclips for 5mm dia. fuses	67
PCB fuseclips for ¼" dia. fuses	68
PCB fuseclips for 1½" dia. and ATC® fuses	69
PCB fuseclips for ¼", ⅜", 1½" & ⅝" fuses	70



5 x 15mm Ferrule Fuses

C515 (axial leads)

C519

Specifications

Description:
Time-delay fuse.

Dimensions:
5 x 15mm
(0.197" X 0.591").

Construction:
Glass tube.

Ratings:

- Volts — 125Vac (3.5-7A)
- 250Vac (125mA-3A)
- Amps — 125mA-7A
- IR — 25A (350mA @ 600Vac)
- 35A (125mA-1A @ 250Vac)
- 100A (1.25-3A @ 250Vac)
- 400A (3.5-7A @ 125Vac)
- 10kA (125mA-3A @ 125Vac)

Agency Information: CE, UL Listed File E19180, Guide JDYX 125mA-250mA and 375mA-3A, UL Recognized, File E19180, Guide JDYX2, 350mA and 3.5A-7A, CSA Certification File 53787, Class 1422-01, 125mA-250mA and 375mA-3A.

Features and Benefits

- Time-delay for closer sizing on inductive circuits.

Typical Application

- Electronic Circuits
- Printed Circuit Boards

Catalog Numbers (Amps)

With Axial Leads

C515-125-R	C515-800-R	C515-2.5-R
C515-250-R	C515-1-R	C515-3-R
C515-350-R	C515-1.25-R	C515-3.5-R
C515-375-R	C515-1.5-R	C515-4-R
C515-500-R	C515-1.6-R	C515-5-R
C515-600-R	C515-2-R	C515-6-R
C515-750-R	C515-2.25-R	C515-7-R

Without Axial Leads

C519-125-R	C519-750-R	C519-2.25-R
C519-250-R	C519-1-R	C519-2.5-R
C519-350-R	C519-1.25-R	C519-3-R
C519-375-R	C519-1.5-R	C519-3.5-R
C519-500-R	C519-1.6-R	C519-4-R
C519-600-R	C519-2-R	C519-5-R



C518 (axial leads)

C520

Specifications

Description:
Fast-acting fuse.

Dimensions:
5 x 15mm
(0.197" X 0.591").

Construction:
Glass tube.

Ratings:

- Volts — 250Vac
- Amps — 100mA-5A
- IR — 35A (100mA-750mA @ 250Vac)
- 10kA (100mA-5A @ 125Vac)
- 100A (1.5-3.5A @ 250Vac)
- 200A (4-5A @ 250Vac)

Agency Information: CE, UL Recognized File E19180, Guide JDYX2CSA Certification File 53787, Class 1422-01.

Features and Benefits

- Small footprint saves space in equipment.
- Fast-acting for maximum component protection.
- Available in ferrule and axial leaded configurations

Typical Applications

- Electronic Circuits
- Printed Circuit Boards

Catalog Numbers (Amps)

With Axial Leads

C518-100-R	C518-750-R	C518-4-R
C518-125-R	C518-2-R	C518-5-R
C518-250-R	C518-2.5-R	
C518-375-R	C518-3-R	
C518-500-R	C518-3.5-R	

Without Axial Leads

C520-100-R	C520-750-R	C520-3.5-R
C520-125-R	C520-1.5-R	C520-4-R
C520-250-R	C520-2-R	C520-5-R
C520-375-R	C520-2.5-R	
C520-500-R	C520-3-R	



C517 (axial leads)

Specifications

Description: Fast-acting fuse.

Construction: Glass tube.

Ratings:

- Volts — 350Vac*
- Amps — 3A
- IR — 100A @ 350Vac
- 100A @ 250Vac
- 10kA @ 125Vac

*350Vac/100A is UL Recognized

Agency Information:

CE, UL Listing File E19180, Guide JDYX, CSA Certification File 53787, Class 1422-01, UL Recognized, File E19180, Guide JDYX2.

- Small footprint saves space in equipment.
- Fast-acting for maximum component protection.
- 350Vac rating for 277V ballast circuit protection.

Typical Applications

- Electronic Circuits
- Printed Circuit Boards
- Electronic Ballast Protection

Catalog Number (Amps)

With Axial Leads
C517-3-R



5 x 20mm European (IEC) Ferrule Fuses

Electronic Fuses

S500-V (GDB-V)* (axial leads)

S500 (GDB)*

Specifications
Description: Fast-acting, low-breaking capacity fuse.

Construction:
 Glass tube, nickel-plated brass endcaps (silver-plated endcaps, 32-125mA).

Ratings:
 Volts — 250Vac (or less)
 Amps — 32mA-10A
 IR — See catalog table

Agency Information: CE, cURus, CSA, SEMKO, VDE, BSI, IMQ, CCC.
 See data sheet for complete agency information. Not all approvals apply to all ratings.

Features and Benefits

- Fast-acting for maximum protection, conforms to IEC 60127-2 (160mA-10A).

Typical Applications

- Electronic Circuits

Catalog Numbers (Amps)

Catalog Numbers	IR (Amps)	I ² t	Max Voltage Drop (mV)
S500-32-R	35	0.000047	3200
S500-40-R	35	0.00011	2500
S500-50-R	35	0.00020	2400
S500-63-R	35	0.00057	2000
S500-80-R	35	0.0012	1200
S500-100-R	35	0.003	1100
S500-125-R	35	0.005	1000
S500-160-R	35	0.008	2000
S500-200-R	35	0.016	1700
S500-250-R	35	0.028	1400
S500-315-R	35	0.058	1300
S500-400-R	35	0.018	1100
S500-500-R	35	0.018	220
S500-630-R	35	0.035	220
S500-800-R	35	0.067	190
S500-1-R	35	0.60	200
S500-1.25-R	35	0.84	200
S500-1.6-R	35	1.6	190
S500-2-R	35	4.2	150
S500-2.5-R	35	6.1	150
S500-3.15-R	35	13	130
S500-4-R	40	22	130
S500-5-R	50	42	120
S500-6.3-R	63	69	120
S500-8-R	80	-	120
S500-10-R	100	—	120

Options

Axial leads, put "V" in P/N,
 *When ordering GDB version, do not add "-R" suffix to part number.

Data Sheet: 2052 (S500), 2015 (GDB)

S501-V (GDA-V)* (axial leads)

S501 (GDA)*

Specifications
Description: Fast-acting, high-breaking capacity fuse.

Construction:
 Ceramic tube, nickel-plated brass endcaps (silver-plated endcaps 50mA-400mA).

Ratings:
 Volts — 250Vac (or less)
 Amps — 50mA-10A**
 IR — 1500A @ 250Vac

Agency Information: CE, cURus, SEMKO, VDE, IMQ, CCC, CSA, BSI.
 See data sheet for complete agency information. Not all approvals apply to all ratings.

Features and Benefits

- Fast-acting for maximum protection.
- High break capacity for use in higher fault energy electronic circuitry.
- Conforming to IEC standards.

Typical Applications

- Electronic Circuits

Catalog Numbers (Amps)

Catalog Numbers	I ² t	Typical Voltage Drop (mV)
S501-50-R	0.0017	9000
S501-63-R	0.0005	3300
S501-80-R	0.0011	2600
S501-100-R	0.0018	2300
S501-125-R	0.0037	1900
S501-160-R	0.008	1600
S501-200-R	0.020	1350
S501-250-R	0.027	1300
S501-315-R	0.010	1400
S501-400-R	0.018	1200
S501-500-R	0.038	1050
S501-630-R	0.064	1200
S501-800-R	0.097	490
S501-1-R	0.146	330
S501-1.25-R	0.313	297
S501-1.6-R	0.748	239
S501-2-R	2.0	205
S501-2.5-R	3.9	190
S501-3.15-R	8.1	160
S501-4-R	14	160
S501-5-R	25	155
S501-6.3-R	48	150
S501-8-R	N/A	N/A
S501-10-R	N/A	N/A

Options

Axial leads, put "V" in P/N.
 *When ordering GDA version, do not add "-R" suffix to part number.

**GDA is not available above 6.3A.

Data Sheet: 2051 (S501), 2014 (GDA)

S505-V (axial leads)

S505

Specifications
Description: Time-delay, high-breaking capacity fuse.

Construction:
 Ceramic tube, silver-plated brass endcaps.

Ratings:
 Volts — 250Vac (or less)
 Amps — 500mA-12A
 IR — 1500A @ 250Vac

Agency Information: UL, CSA, SEMKO, VDE, BSI, IMQ, PSE/JET, CCC, EK, FIMKO.

See data sheet for complete agency information. Not all approvals apply to all ratings.

Features and Benefits

- Time-delay performance ideal for inductive circuits.
- Conforming to IEC standards.

Typical Applications

- Electronic Circuits

Catalog Numbers (Amps)

Catalog Numbers	Typical I ² t	Max Voltage Drop (mV)
S505-500-R	0.188*	295
S505-800-R	0.632*	189
S505-1-R	1.28	152.5
S505-1.25-R	2.22	150
S505-1.6-R	6.78	125
S505-2-R	9.60	118.5
S505-2.5-R	16.60	115
S505-3.15-R	36.60	102.5
S505-4-R	38.45*	86.5
S505-5-R	71.30*	77.5
S505-6.3-R	197	75
S505-8-R	311	75
S505-10-R	397	72
S505-12-R	713.7*	77

*The typical I²t value was measured at 10 times of rated current under DC

Options

Axial leads, put "V" in P/N.

Data Sheet: 2037

5 x 20mm European (IEC) Ferrule Fuses

S506-V (GDC-V)* (axial leads)

S506 (GDC)*

Specifications

Description: Time-delay, low-breaking capacity fuse.

Construction: Glass tube, nickel-plated brass endcaps.

Ratings:

- Volts — 250Vac (or less)
- Amps — 32mA-15A**
- IR — 35A @ 250Vac



Agency Information: UR, CSA, cURus, SEMKO, VDE, BSI, IMQ, PSE/JET, CCC.

See data sheet for complete agency information. Not all approvals apply to all ratings.

Features and Benefits

- Time-delay compatibility for inductive circuits.
- Conforming to IEC standards.

Typical Applications

- Electronic Circuits

Catalog Numbers (Amps)

Catalog Numbers	Typical I^2t	Max Voltage Drop (mV)
S506-32-R	0.0051	1050
S506-40-R	0.0072	920
S506-50-R	0.0095	800
S506-63-R	0.021	760
S506-80-R	0.038	580
S506-100-R	0.045	490
S506-125-R	0.063	390
S506-160-R	0.093	320
S506-200-R	0.114	340
S506-250-R	0.265	270
S506-315-R	0.621	250
S506-400-R	0.872	210
S506-500-R	0.827	140
S506-630-R	1.33	150
S506-800-R	2.78	75
S506-1-R	6.45	87.5
S506-1.25-R	10.05	86
S506-1.6-R	21.7	82
S506-2-R	31.6	77
S506-2.5-R	59.4	72.5
S506-3.15-R	96.4	68.5
S506-4-R	71.8	67
S506-5-R	142.5	60.5
S506-6.3-R	237.6	54
S506-8-R	255.8	55
S506-10-R	450	54
S506-12.5-R	1019.5	45
S506-15-R	1091.7	65.5

Options

Axial leads, put "V" in P/N.

*When ordering GDC version, do not add "-R" suffix to part number.

**GDC series is not available above 6.3A.

Data Sheet: 2016 (GDC), 4332 (S506)

5 x 20mm North American (UL) Ferrule Fuses

GMA-V (axial leads)

GMA

Specifications

Description:

Fast-acting fuse.

Dimensions:

5 x 20mm
(0.197" x 0.788").

Construction:

Glass tube, nickel-plated brass endcaps.



Ratings:

- Volts — 250Vac (63mA-2.5A)
- 125Vac (3.15-15A)
- Amps — 63mA-15A
- IR — 35A (63mA- 1A @ 250Vac, p.f. = 0.7-0.8)
- 10kA (63mA-6A @ 125Vac, p.f. = 0.7-0.8)
- 100A (1.25-2.5A @ 250Vac, p.f. = 0.7-0.8)
- 200A (7-8A @ 125Vac, p.f. = 1.0)
- 150A (10-15A @ 125Vac, p.f. = 1.0)

Agency Information: CE, Std. 248-14 UL Listed Guide JDYX, File E19180, 0-6A, UL Recognized, Guide JDYX2, File E19180, 7-15A, CSA Certified, Class 1422-01, File 53787, 0-6.

Features and Benefits

- Fast-acting for maximum protection.

Typical Applications

- Electronic Circuits

Catalog Numbers (Amps)

With Axial Leads

GMA-V-63-R	GMA-V-800-R	GMA-V-4-R
GMA-V-100-R	GMA-V-1-R	GMA-V-5-R
GMA-V-125-R	GMA-V-1.25-R	GMA-V-6-R
GMA-V-200-R	GMA-V-1.5-R	GMA-V-7-R
GMA-V-250-R	GMA-V-1.6-R	GMA-V-8-R
GMA-V-300-R	GMA-V-2-R	GMA-V-10-R
GMA-V-500-R	GMA-V-2.5-R	GMA-V-15-R
GMA-V-600-R	GMA-V-3.15-R	
GMA-V-750-R	GMA-V-3.5-R	

Without Axial Leads

GMA-63-R	GMA-800-R	GMA-4-R
GMA-100-R	GMA-1-R	GMA-5-R
GMA-125-R	GMA-1.25-R	GMA-6-R
GMA-200-R	GMA-1.5-R	GMA-7-R
GMA-250-R	GMA-1.6-R	GMA-8-R
GMA-300-R	GMA-2-R	GMA-10-R
GMA-500-R	GMA-2.5-R	GMA-15-R
GMA-600-R	GMA-3.15-R	
GMA-750-R	GMA-3.5-R	

Data Sheet: 2017

GMC-V (axial leads)

GMC

Specifications

Description: Medium time-delay fuse.

Dimensions: 5 x 20mm (0.197" x 0.788").

Construction: Glass tube, nickel-plated brass endcaps.

Ratings:

- Volts — 250Vac (63mA-3.15A)
- 125Vac (3.5-10A)
- Amps — 63mA-10A
- IR — 35A (63mA- 1A @ 250Vac, p.f. = 0.7-0.8)
- 10kA (63mA-6A @ 125Vac, p.f. = 0.7-0.8)
- 100A (1.25-3.15A @ 250Vac, p.f. = 0.7-0.8)
- 200A (6.3-10A @ 125Vac, p.f. = 1.0)

Agency Information: CE, Std. 248-14, UL Listed Guide JDYX, File E19180, 0-6.3A, UL Recognized, Guide JDYX2, File E19180, 7-8A, CSA Certified, Class 1422-01, File 53787, 0-6.3A.

Features and Benefits

- Conforming to UL standards.

Typical Applications

- Electronic Circuits

Catalog Numbers (Amps)

With Axial Leads

GMC-V-63-R	GMC-V-500-R	GMC-V-2.5
GMC-V-80-R	GMC-V-600-R	GMC-V-3.15
GMC-V-100-R	GMC-V-630-R	GMC-V-3.5
GMC-V-125-R	GMC-V-750-R	GMC-V-4
GMC-V-150-R	GMC-V-800-R	GMC-V-5
GMC-V-200-R	GMC-V-1-R	GMC-V-6
GMC-V-250-R	GMC-V-1.25-R	GMC-V-6.3
GMC-V-300-R	GMC-V-1.5-R	GMC-V-7
GMC-V-315-R	GMC-V-1.6-R	GMC-V-8
GMC-V-400-R	GMC-V-2-R	GMC-V-10

Without Axial Leads

GMC-63mA	GMC-500-R	GMC-2.5-R
GMC-80mA	GMC-600-R	GMC-3.15-R
GMC-100mA	GMC-630-R	GMC-3.5-R
GMC-125mA	GMC-750-R	GMC-4-R
GMC-150mA	GMC-800-R	GMC-5-R
GMC-200mA	GMC-1-R	GMC-6-R
GMC-250mA	GMC-1.25-R	GMC-6.3-R
GMC-300mA	GMC-1.5-R	GMC-7-R
GMC-315mA	GMC-1.6-R	GMC-8-R
GMC-400mA	GMC-2-R	GMC-10-R

Data Sheet: 2018

GMD-V (axial leads)

GMD

Specifications

Description: Time-delay fuse.

Dimensions:

5 x 20mm
(0.197" x 0.788").

Construction:

Glass tube, nickel-plated brass endcaps.



Ratings:

- Volts — 250Vac
- Amps — 125mA-4A
- IR — 10kA (125mA-3A @ 125Vac, p.f. = 0.7-0.8)
- 10kA (4A @ 125Vac, p.f. = 1.0)
- 35A (125mA-1A @ 250Vac, p.f. = 0.7-0.8)
- 100A (1.2A-3A @ 250Vac, p.f. = 0.7-0.8)
- 200A (4A @ 250Vac, p.f. = 1.0)

Agency Information: CE, UL Listed Guide JDYX, File E19180, 125mA-3A, UL Recognized, Guide JDYX2, File E19180, 4A, CSA Certified, Class 1422-01, File 53787, 0-4A, PSE/JET. File 1641-31003-1001, 1.2A-4A.

Features and Benefits

- Time-delay compatibility for inductive circuits.
- Conforming to UL standards.

Typical Applications

- Electronic Circuits

Catalog Numbers (Amps)

With Axial Leads

GMD-V-125-R	GMD-V-500-R	GMD-V-1.5-R
GMD-V-150-R	GMD-V-600-R	GMD-V-1.6-R
GMD-V-200-R	GMD-V-630-R	GMD-V-2-R
GMD-V-250-R	GMD-V-750-R	GMD-V-2.5-R
GMD-V-300-R	GMD-V-800-R	GMD-V-3-R
GMD-V-315-R	GMD-V-1-R	GMD-V-4-R
GMD-V-375-R	GMD-V-1.2-R	
GMD-V-400-R	GMD-V-1.25-R	

Without Axial Leads

GMD-125-R	GMD-500-R	GMD-1.5-R
GMD-150-R	GMD-600-R	GMD-1.6-R
GMD-200-R	GMD-630-R	GMD-2-R
GMD-250-R	GMD-750-R	GMD-2.5-R
GMD-300-R	GMD-800-R	GMD-3-R
GMD-315-R	GMD-1-R	GMD-4-R
GMD-375-R	GMD-1.2-R	
GMD-400-R	GMD-1.25-R	

Data Sheet: 2019

Electronic Fuses

1/4" Dia. x 5/8" to 1" Length Ferrule Fuses

AGA-V (axial leads)

AGA

Specifications
Description: Fast-acting fuse.

Dimensions:
 1/4" x 5/8"
 (6.4 x 15.9mm).

Construction:
 Glass tube.

Ratings:

- Volts — 125Vac (or less)
- Amps — 1-30A
- IR — 10kA (1-1 1/2A @ 125Vac)
- 200A (2-5A @ 125Vac)
- 1000A (6-30A @ 32Vac)

Agency Information: CE, Std. 248-14, UL File E19180, UL Listed, Guide JDYX 0-1 1/2A UL Recognized, Guide JDYX2 2-12A.

Features and Benefits

- Fast-acting for maximum protection.
- Size rejects insertion of other fuse types.

Typical Applications

- Electronic Circuits

Catalog Numbers (Amps)

With Axial Leads*

AGA-V-1	AGA-V-5	AGA-V-15
AGA-V-1-1/2	AGA-V-6	AGA-V-20
AGA-V-2	AGA-V-7	AGA-V-25
AGA-V-2-1/2	AGA-V-7-1/2	AGA-V-30
AGA-V-3	AGA-V-10	

Without Axial Leads

AGA-1	AGA-5	AGA-15
AGA-1-1/2	AGA-6	AGA-20
AGA-2	AGA-7	AGA-25
AGA-2-1/2	AGA-7-1/2	AGA-30
AGA-3	AGA-10	

*AGA-V is UL Listed 0-5A, UL Recognized 6-12A.



AGW

Specifications
Description: Fast-acting fuse.

Dimensions: 1/4" x 7/8"
 (6.4 x 22.2mm).

Construction: Glass tube.

Ratings:

- Volts — 32Vac
- Amps — 1-30A

Features and Benefits

- Fast-acting for maximum protection.

Typical Applications

- Electronic Circuits

Catalog Numbers (Amps)

AGW-1	AGW-4	AGW-15
AGW-1-1/2	AGW-5	AGW-20
AGW-2	AGW-6	AGW-25
AGW-2-1/2	AGW-7-1/2	AGW-30
AGW-3	AGW-10	



AGX

Specifications
Description: Fast-acting fuse.

Dimensions: 1/4" x 1"
 (6.4 x 25.4mm).

Construction: Glass tube.

Ratings:

- Volts — 250Vac (1/200-2A)
- 125Vac (2 1/2-7A)
- 32V (8-30A)
- Amps — 1/4-30A
- IR — 35A (1/4-1/2A @ 250Vac)
- 100A (3/4-2A @ 250Vac)
- 10kA (1/4-5A @ 125Vac)
- 1000A (5-6A @ 125Vac)
- 1000A (8-30A @ 32Vac)

Agency Information: CE, Std. 248-14, UL File E19180 UL Listed, Guide JDYX, 0-5A UL Recognized, Guide JDYX2, 6-20A CSA File 53787; Class 1422-01.

Features and Benefits

- Size rejects insertion of other fuse types.

Typical Applications

- Electronic Circuits

Catalog Numbers (Amps)

AGX-1/4	AGX-1-1/2	AGX-8
AGX-3/10	AGX-2	AGX-10
AGX-3/8	AGX-2-1/2	AGX-15
AGX-1/2	AGX-3	AGX-20
AGX-3/4	AGX-4	AGX-25
AGX-1	AGX-5	AGX-30
AGX-1-1/4	AGX-6	
	AGX-7	



1/4" Dia. x 1 1/4" Length Fast-acting Ferrule Fuses

Electronic Fuses

AGC (AGC-V axial leads)

Specifications Description:

Fast-acting fuse.

Dimensions: 1/4" x 1 1/4"
(6.4 x 31.7mm).

Construction: Glass tube with nickel-plated brass endcaps.

Ratings:

Volts — 250Vac (1/20-10A)
— 32Vac (12-30A)

Amps — 1/20-30A

- IR — 35A (1/20-1A @ 250Vac)
- 100A (1 1/4-3A @ 250Vac)
- 200A (4-10A @ 250Vac)
- 10kA (1/20-10A @ 125Vac)
- 1000A (12-30A @ 32Vac)



Agency Information: CE, UL Listed, Guide JDYX, File E19180, 0-10A UL Recognized, Guide JDYX2, File E19180, 12-30A CSA Certification, Class 1422-01, File 053787, 1/20-30A.

Features and Benefits

- Original electronic glass tube fuse.
- Fast-acting for maximum protection.
- Wide amp/volt ratings allow versatility of protecting electronic circuits.

Typical Applications

- Electronic Circuits

Catalog Numbers (Amps)

With Axial Leads

AGC-V-1/20-R	AGC-V-1-R	AGC-V-7-1/2-R
AGC-V-1/10-R	AGC-V-1-1/4-R	AGC-V-8-R
AGC-V-1/10-R	AGC-V-1-1/2-R	AGC-V-9-R
AGC-V-1/8-R	AGC-V-2-R	AGC-V-10-R
AGC-V-1/10-R	AGC-V-2-1/4-R	AGC-V-12-R
AGC-V-1/10-R	AGC-V-2-1/2-R	AGC-V-14-R
AGC-V-1/4-R	AGC-V-3-R	AGC-V-15-R
AGC-V-1/10-R	AGC-V-4-R	AGC-V-20-R
AGC-V-1/8-R	AGC-V-5-R	AGC-V-25-R
AGC-V-1/2-R	AGC-V-6-R	AGC-V-30-R
AGC-V-1/2-R	AGC-V-7-R	

Without Axial Leads

AGC-1/20-R	AGC-1-R	AGC-7-1/2-R
AGC-1/10-R	AGC-1-1/4-R	AGC-8-R
AGC-1/10-R	AGC-1-1/2-R	AGC-9-R
AGC-1/8-R	AGC-2-R	AGC-10-R
AGC-1/10-R	AGC-2-1/4-R	AGC-12-R
AGC-1/10-R	AGC-2-1/2-R	AGC-14-R
AGC-1/4-R	AGC-3-R	AGC-15-R
AGC-1/10-R	AGC-4-R	AGC-20-R
AGC-1/8-R	AGC-5-R	AGC-25-R
AGC-1/2-R	AGC-6-R	AGC-30-R
AGC-1/2-R	AGC-7-R	

Data Sheet: 2001

ABC (ABC-V axial leads)

Specifications Description:

Fast-acting fuse.

Dimensions: 1/4" x 1 1/4"
(6.4 x 31.7mm).

Construction: Ceramic tube with nickel-plated brass endcaps.

Ratings:

Volts — 250Vac/125Vdc
(1/4-15A, 20-30A)*

— 250Vac (18A)

Amps — 1/4-30A

- IR** — 35A (1/4-1A @ 250Vac)
- 100A (1 1/4-3A @ 250Vac)
- 200A (4-10A @ 250Vac)
- 750A (12-15A @ 250Vac)
- 400A (18-20A @ 250Vac)
- 10kA (1/4-15A @ 125Vac)
- 1kA (18-30A @ 125Vac)
- 10kA (1/4-15, 20A @ 125Vdc)
- 400A (25-30A @ 125Vdc)
- 200A (25-30A @ 250Vac)



*CSA approvals for 25A and 30A are at 125Vac – IR 1000A and Vdc – IR 400A (IR 1000A at 75Vdc)

**Interrupting ratings measured at 70% – 80% power factor on AC. The interrupting ratings for 18A and 20A were measured at 85%-95% power factor on AC. The interrupting ratings for 25A and 30A were measured at 89% power factor on AC.

Agency Information: CE, Std. 248-14 UL Listed, Guide JDYX File E19180, 1/4-15A; UL Recognized, Guide JDYX2, File E19180, 18-30A; CSA Certification, Class 1422-01 & 1422-30, File 53787, 1/4-30A.

Features and Benefits

- Ceramic body allows for higher amp/volt rating combinations.

Typical Applications

- Electronic Circuits

Catalog Numbers (Amps)

With Axial Leads

ABC-V-1/4-R	ABC-V-3-R	ABC-V-12-R
ABC-V-1/2-R	ABC-V-4-R	ABC-V-15-R
ABC-V-1/2-R	ABC-V-5-R	ABC-V-18-R
ABC-V-1-R	ABC-V-6-R	ABC-V-20-R
ABC-V-1-1/2-R	ABC-V-7-R	ABC-V-25-R
ABC-V-2-R	ABC-V-8-R	ABC-V-30-R
ABC-V-2-1/2-R	ABC-V-10-R	

Without Axial Leads

ABC-1/4-R	ABC-3-R	ABC-12-R
ABC-1/2-R	ABC-4-R	ABC-15-R
ABC-1/2-R	ABC-5-R	ABC-18-R
ABC-1-R	ABC-6-R	ABC-20-R
ABC-1-1/2-R	ABC-7-R	ABC-25-R
ABC-2-R	ABC-8-R	ABC-30-R
ABC-2-1/2-R	ABC-10-R	

Data Sheet: 2000

GBB (GBB-V axial leads)

Specifications Description:

Very fast-acting fuse.

Dimensions: 1/4" x 1 1/4"
(6.4 x 31.7mm).

Construction: Ceramic cartridge with nickel-plated brass endcaps.

Ratings:

Volts — 250Vac/125Vdc

Amps — 1-30A

- IR — 200A @ 250Vac
- 200A (20-30A @ 125Vac/dc)
- 10,000A (1A -15A @ 125Vac/dc)



Agency Information:

CE, Std. 248-14, UL Recognized, 1-30,125Vdc/250Vac, File E56412, Guide JFHR2, CSA Accepted, 1-30, 125Vdc/250Vac, File 53787, Class 1422-30.

Features and Benefits

- Very fast-acting performance allows protection of highly sensitive electronic circuitry.

Typical Applications

- Electronic Circuits

Catalog Numbers (Amps)

With Axial Leads

GBB-V-1-R	GBB-V-6-R	GBB-V-15-R
GBB-V-1-1/4-R	GBB-V-7-R	GBB-V-20-R
GBB-V-2-R	GBB-V-8-R	GBB-V-25-R
GBB-V-3-R	GBB-V-9-R	GBB-V-30-R
GBB-V-4-R	GBB-V-10-R	
GBB-V-5-R	GBB-V-12-R	

Without Axial Leads

GBB-1-R	GBB-6-R	GBB-15-R
GBB-1-1/4-R	GBB-7-R	GBB-20-R
GBB-2-R	GBB-8-R	GBB-25-R
GBB-3-R	GBB-9-R	GBB-30-R
GBB-4-R	GBB-10-R	
GBB-5-R	GBB-12-R	

Data Sheet: 2013

1/4" Dia. x 1 1/4" Length Time-delay Ferrule Fuses

MDL-V (axial leads)

MDL

Specifications Description:
Time-delay fuse.

Dimensions: 1/4" x 1 1/4"
(6.4 x 31.7mm).

Construction: Glass tube with nickel-plated brass endcaps.

Ratings:

- Volts — 250Vac (1/6-8A)
- 32Vac (9-30A)
- Amps — 1/6-30A
- IR* — 35A (1/6-1A @ 250Vac)
- 100A (1 1/4-3A @ 250Vac)
- 200A (4-8A @ 250Vac)
- 10000A (1/6-8A @ 125Vac)
- 1000A (9-30A @ 32Vac)



*Interrupting ratings were measured at 70% – 80% power factor on AC, and at a time constant described in UL 198L.

Agency Information: CE, UL Listed, Guide JDYX, File E19180, 1/6-8A; CSA Certification Class 1422-01, 1/6-8A; UL Recognized, Guide JDYX2, File E19180, 9-30A; CSA Component Acceptance, Class 142230, 9-30A.

Features and Benefits

- Time-delay allows close sizing on inductive circuits.

Typical Applications

- Electronic Circuits

Catalog Numbers (Amps)

With Axial Leads

MDL-V-1/10-R	MDL-V-1-R	MDL-V-7-R
MDL-V-1/10-R	MDL-V-1-1/4-R	MDL-V-8-R
MDL-V-1/6-R	MDL-V-1-1/2-R	MDL-V-9-R
MDL-V-3/10-R	MDL-V-2-R	MDL-V-10-R
MDL-V-3/10-R	MDL-V-2-1/4-R	MDL-V-12-R
MDL-V-1/4-R	MDL-V-2-1/2-R	MDL-V-15-R
MDL-V-3/10-R	MDL-V-3-R	MDL-V-20-R
MDL-V-3/6-R	MDL-V-4-R	MDL-V-25*
MDL-V-1/2-R	MDL-V-5-R	MDL-V-30*
MDL-V-3/4-R	MDL-V-6-R	

Without Axial Leads

MDL-1/10-R	MDL-1-R	MDL-7-R
MDL-1/10-R	MDL-1-1/4-R	MDL-8-R
MDL-1/6-R	MDL-1-1/2-R	MDL-9-R
MDL-3/10-R	MDL-2-R	MDL-10-R
MDL-3/10-R	MDL-2-1/4-R	MDL-12-R
MDL-1/4-R	MDL-2-1/2-R	MDL-15-R
MDL-3/10-R	MDL-3-R	MDL-20-R
MDL-3/6-R	MDL-4-R	MDL-25*
MDL-1/2-R	MDL-5-R	MDL-30*
MDL-3/4-R	MDL-6-R	

*MDL-25 & MDL-30 are not available in RoHS compliant construction.

Data Sheet:2004

MDQ-V (axial leads)

MDQ

Specifications Description:
Dual-element, time-delay fuse.

Dimensions: 1/4" x 1 1/4"
(6.4 x 31.7mm).

Construction: Glass tube with nickel-plated brass endcaps.

Ratings:

- Volts — 250Vac (1/100-7A)
- 32Vac (7 1/2-15A)
- Amps — 1/100-15A
- IR — 35A (1/100-1A @ 250Vac)
- 100A (1 1/4-3A @ 250Vac)
- 200A (4-7A @ 250Vac)
- 1000A (7 1/2-12A @ 32Vac)



Agency Information: Std. 248-14, UL Listed, File E19180; Guide JDYX, 1/6-7A CSA Certification, File 47233, Class 1422-01, 1/6-7A, UL Recognized, Guide JDYX2, File E19180, 7.1-30A.

Features and Benefits

- Dual-element design allows closer sizing to inductive circuits than any other fuses.

Typical Applications

- Electronic Relay and Control Circuits

Catalog Numbers (Amps)

With Axial Leads

MDQ-V-1/100	MDQ-V-3/6	MDQ-V-1-1/2	MDQ-V-5
MDQ-V-1/2	MDQ-V-3/4	MDQ-V-1-3/4	MDQ-V-6
MDQ-V-1/6	MDQ-V-3/8	MDQ-V-1-5/8	MDQ-V-6-1/2
MDQ-V-1/10	MDQ-V-1/2	MDQ-V-2	MDQ-V-7
MDQ-V-1/6	MDQ-V-3/8	MDQ-V-2-1/4	MDQ-V-7-1/2
MDQ-V-1 1/2	MDQ-V-3/4	MDQ-V-2-1/2	MDQ-V-8
MDQ-V-1 7/10	MDQ-V-3/8	MDQ-V-2-3/4	MDQ-V-9
MDQ-V-3/6	MDQ-V-1	MDQ-V-3	MDQ-V-10
MDQ-V-3/6	MDQ-V-1-1/10	MDQ-V-3-3/10	MDQ-V-12
MDQ-V-3/4	MDQ-V-1-1/4	MDQ-V-4	MDQ-V-15

Without Axial Leads

MDQ-1/100	MDQ-3/6	MDQ-1-1/2	MDQ-5
MDQ-1/2	MDQ-3/4	MDQ-1-3/4	MDQ-6
MDQ-1/6	MDQ-3/8	MDQ-1-5/8	MDQ-6-1/2
MDQ-1/10	MDQ-1/2	MDQ-2	MDQ-7
MDQ-1/6	MDQ-3/8	MDQ-2-1/4	MDQ-7-1/2
MDQ-1 1/2	MDQ-3/4	MDQ-2-1/2	MDQ-8
MDQ-1 7/10	MDQ-3/8	MDQ-2-3/4	MDQ-9
MDQ-3/6	MDQ-1	MDQ-3	MDQ-10
MDQ-3/6	MDQ-1-1/10	MDQ-3-3/10	MDQ-12
MDQ-3/4	MDQ-1-1/4	MDQ-4	MDQ-15

Data Sheet: 2044

MDA-V (axial leads)

MDA

Specifications Description:
Time-delay fuse.

Dimensions: 1/4" x 1 1/4" (6.35 x 31.75mm).

Construction: Ceramic tube with nickel-plated brass endcaps.

Ratings:

- Volts — 250Vac (or less)
- 125Vdc (20A- 30A)
- Amps — 1/4-30A
- IR** — 35A (1/4-1A @ 250Vac)
- 100A (1 1/2-2A @ 250Vac)
- 200A (2 1/2-10A @ 250Vac)
- 750A (12-15A @ 250Vac)
- 1500A (20-30A @ 250Vac)
- 10kA (1/4-30A @ 125Vac)
- 10kA (20-30A @ 125Vdc)



**Interrupting ratings were measured at 70% – 80% power factor on AC, and at a time constant described in UL 248.

Agency Information: CE, Std. 248-14, UL Listed, Guide JDYX, File E19180, 0-20A CSA Certification, Class 1422-01, File 53787, 0-20A. UL Recognized, Guide JDYX2, File E19180, 25-30A, CSA Component Acceptance, Class 1422-30, 25-30A

Features and Benefits

- Ceramic body allows for higher amp/volt rating combinations.
- Inventory consolidation by replacing MDL fuses allows for reduced SKU investment and minimizing potential for misapplying fuse.

Typical Applications

- Electronic Circuits

Catalog Numbers (Amps)

With Axial Leads

MDA-V-1/6-R	MDA-V-3-R	MDA-V-12-R
MDA-V-1/6-R	MDA-V-4-R	MDA-V-15-R
MDA-V-3/6-R	MDA-V-5-R	MDA-V-20-R
MDA-V-1-R	MDA-V-6-R	MDA-V-25-R
MDA-V-1-1/6-R	MDA-V-7-R	MDA-V-30-R
MDA-V-2-R	MDA-V-8-R	
MDA-V-2-1/6-R	MDA-V-10-R	

Without Axial Leads

MDA-1/6-R	MDA-3-R	MDA-12-R
MDA-1/6-R	MDA-4-R	MDA-15-R
MDA-3/6-R	MDA-5-R	MDA-20-R
MDA-1-R	MDA-6-R	MDA-25A-R
MDA-1-1/6-R	MDA-7-R	MDA-30A-R
MDA-2-R	MDA-8-R	
MDA-2-1/6-R	MDA-10-R	

Data Sheet: 2002

PC Board Mount Fuse Holders

Electronic Fuses

HTC-45M



PCB Vertical Mount

Specifications

Description: PCB vertical mount bayonet cap and fuse holder.

Dimensions: See Dimensions illustration.

Ratings:

See Specifications table.

Dimensions - in (mm)

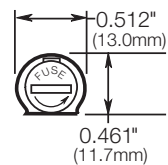
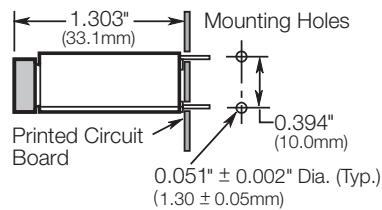

Data Sheet 2110

HTC-50M



PCB Horizontal Mount

Specifications

Description: PCB horizontal mount bayonet cap and fuse holder.

Dimensions: See Dimensions illustration.

Ratings:

See Specifications table.

Dimensions - in (mm)

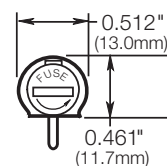
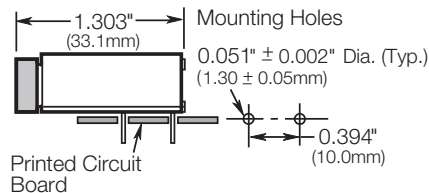

Data Sheet 2110

HTC-60M, HTC-65M



PCB Stand-Off Mount

Specifications

Description: Four-leg PCB stand-off fuse holder.

Dimensions: See Dimensions illustration.

Ratings:

Volts: — 250V

Amps: — 6.3A

Dimensions - in (mm)

HTC-65M (4-Leg)

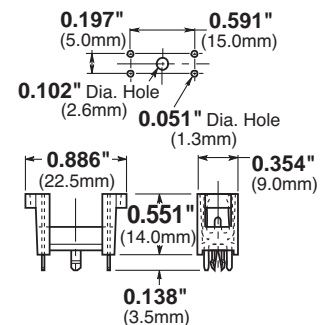

Data Sheet 2110

Specifications

Volts: 250V

Amps: UR: 10A, VDE: 6.3A

Terminals: For HTC-45M, HTC-50M Tin-plated.

Molded Materials: High temperature thermoplastic that meets the flammability ratings of UL 94V0; Glow Wire Test: 960°C per IEC 695-2-1.

Solderability: In accordance with IEC 68-2-20.

Electrical: Contact Resistance: ≤ 10mΩ; Insulation Resistance: ≥ 10 megohm; Dielectric Strength ≥ 2000 Vac.

Shock Safety: PC2 (fuse holders).

Agency Information: CE, HTC-45M, HTC-50M UL Recognized, (Guide IZLT8, File E14853; VDE HTC-45M & HTC-50M File: 40004456; HTC-65M File: 40004455.

Packaging: Standard Qty 10 (No Prefix), Bulk Qty 100 (Prefix Catalog Number with BK/).

PC Board Mount Fuse Holders

HBH-I (for 1/4" x 1 1/4" fuses)

HBH-M (for 5 x 20mm fuses)

PCB Horizontal Mount

Specifications
Description: PCB horizontal mount fuse holder.

Dimensions: See Dimensions illustration.

Ratings:
 See Specifications table.

Dimensions - in (mm)

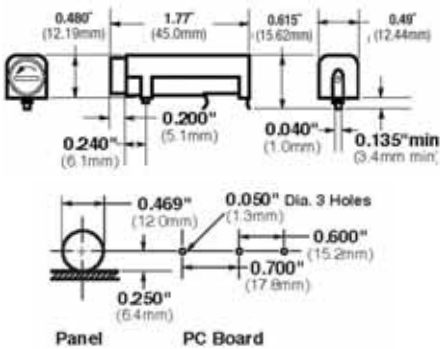

Data Sheet: 2118

HBV-I (for 1/4" x 1 1/4" fuses)

HBV-M (for 5 x 20mm fuses)

PCB Vertical Mount with Stability Pins

Specifications
Description: PCB vertical mount fuse holder with stability pins.

Dimensions: See Dimensions illustration.

Ratings:
 See Specifications table.

Dimensions - in (mm)

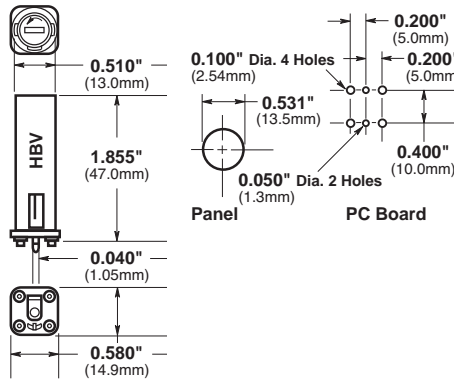

Data Sheet: 2118

HBW-I (for 1/4" x 1 1/4" fuses)

HBW-M (for 5 x 20mm fuses)

PCB Vertical Mount without Stability Pins

Specifications
Description: PCB vertical mount fuse holder without stability pins.

Dimensions: See Dimensions illustration.

Ratings:
 See Specifications table.

Dimensions - in (mm)

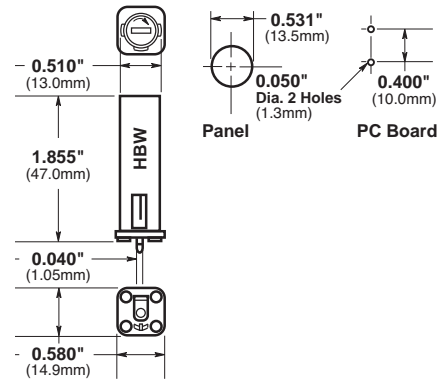

Data Sheet: 2118



FBI



FBM

Fuse Holder Caps (Fit all three shown above)

Specifications

Electrical Ratings: UL — 16A @ 250V; CSA — 12A @ 250V; VDE — 6.3A @ 250V; SEMKO — 10A @ 250V
Insulation resistance — 10 megohm at 500Vdc. **Contact resistance** — less than 0.005 ohms @ 200mV. **Dielectric strength** — over 200V/mil.

Molded Material: High dielectric molded phenolic with a UL 94V0 flammability rating.

Fuse Carrier & Knob: Spring-loaded, bayonet-type. Tin plated brass. Screwdriver slotted.

Mounting: "Kicked" terminals (all models) and stabilizer pins on HBV & HBW models for increased stability.

Temperature Rating (RTI): Body: 150°C, Knob: 130°C

Agency Information: CE, UL Recognized — Guide IZLT2, File EI4853;
 CSA Certified — Class 6225-01, File 47235
 VDE — 4009241 (HBV, HBW)
 SEMKO — 800444

PC Board Fuseclips for 5mm Diameter Fuses

HTC-15M, HTC-140M

PCB Mounted Fuse Holder & Snap-On Cover

Voltage Rating: 250V, 6.3A, 1.6W

HTC-15M (fuse holder), HTC-140M (natural cover),
HTC-150M* (transparent cover)

*Available in bulk only. Use this format: BK/HTC-150M
Data Sheet: 2110

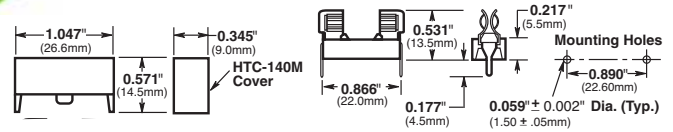

HTC-200M

PCB Mounted Fuseclip

Construction: Tin-plated bronze

Tape and Fan Fold packed

Ammo Pack (AP/HTC-200M) 1000 pieces per box

Data Sheet: 2110

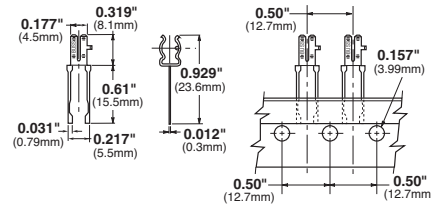

HTC-210M

PCB Mounted Fuseclip with End Stops

Data Sheet: 2110

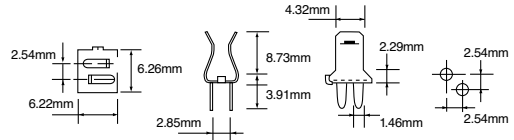

1A3399 Series

PCB Fuseclips with End Stops & Straight Leads

Catalog Numbers	Clip Material*	Finish
1A3399-01	Beryllium copper*	Silver
1A3399-04-R	Beryllium copper*	Bright tin
1A3399-10-R	Spring bronze	Bright tin

*Beryllium copper recommended for amps higher than 15 amps.
Data Sheet: 2131

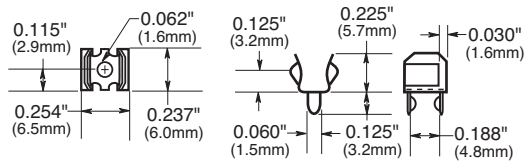

1A5018 Series

PCB High Profile Fuseclips with End Stops & Straight Leads

Catalog Numbers	Clip Material*	Finish
1A5018-7	Spring bronze	Silver
1A5018-10-R	Spring bronze	Bright tin

*Beryllium copper recommended for amps higher than 15 amps.
Data Sheet: 2131

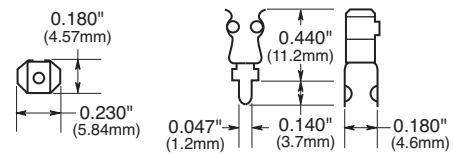

1A5601 Series

PCB Fuseclips (0-7A)

Catalog Number	Clip Material	Finish
1A5601	Cartridge brass	Bright tin

Data Sheet: 2131

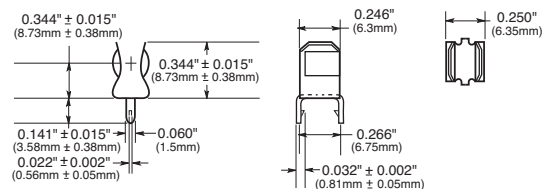

1A5602 Series

PCB Fuseclips (0-7A)

Catalog Number	Clip Material	Finish
1A5602	Cartridge brass	Bright tin

Data Sheet: 2131

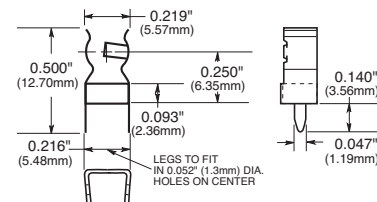

PC Board Fuseclips for 1/4" Diameter Fuses

1A3398 Series

PCB Fuseclips without End Stops with Straight Leads

Catalog Numbers	Clip Material	Finish
1A3398-07-R	Cartridge brass	Bright tin

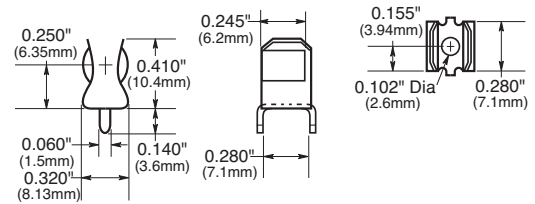

1A1907 Series

PCB Fuseclips with End Stops & Straight Leads

Catalog Numbers	Clip Material*	Finish
1A1907-02	Cartridge brass	None/bright dipped
1A1907-03-R	Beryllium copper*	Bright tin
1A1907-05	Beryllium copper*	Silver
1A1907-06-R	Cartridge brass	Bright tin

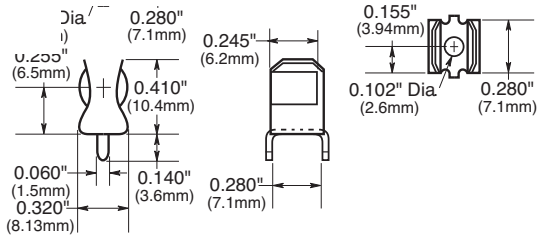

*Beryllium copper recommended for amps higher than 15A.
Data Sheet: 2131

1A4533 Series

PCB Fuseclips without End Stops or Angled Out Leads

Catalog Numbers	Clip Material*	Finish
1A4533-01-R	Beryllium copper*	Bright tin
1A4533-06-R	Cartridge brass	Bright tin

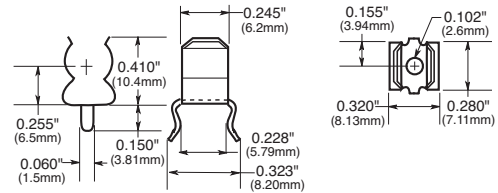

*Beryllium copper recommended for amps higher than 15A.
Data Sheet: 2131

1A4534 Series

PCB Fuseclips with End Stops & Angled Out Leads

Catalog Numbers	Clip Material*	Finish
1A4534-01-R	Beryllium copper*	Bright tin
1A4534-06-R	Cartridge brass	Bright tin

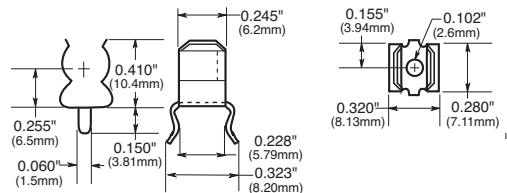

*Beryllium copper recommended for amps higher than 15A.
Data Sheet: 2131

1A1119 Series

Fuseclips with End Stops & Angled In Leads

Catalog Numbers	Clip Material*	Finish
1A1119-04-R	Beryllium copper*	Bright tin
1A1119-05	Beryllium copper*	Silver
1A1119-10-R	Cartridge brass	Bright tin

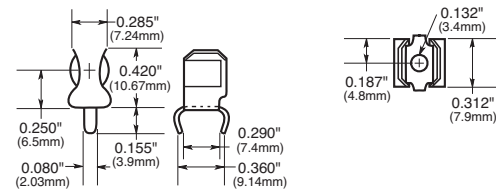

*Beryllium copper recommended for amps higher than 15A.
Data Sheet: 2131

1A1120 Series

PCB Fuseclips without End Stops or Angled In Leads

Catalog Numbers	Clip Material*	Finish
1A1120-02	Cartridge brass	None/bright dipped
1A1120-05	Beryllium copper*	Silver
1A1120-06-R	Beryllium copper*	Bright tin
1A1120-09-R	Cartridge brass	Bright tin

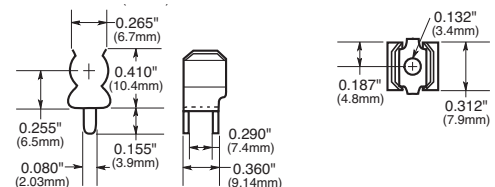

*Beryllium copper recommended for amps higher than 15A.
Data Sheet: 2131

PC Board Fuseclips for $1\frac{3}{32}$ " Diameter, ATM and ATC® fuses

Electronic Fuses

1A3400 Series

PCB Fuseclips for $1\frac{3}{32}$ " diameter fuses with End Stops & Straight Leads

Catalog Number	Amp Rating	Clip Material	Finish
1A3400-09	20A Max.	Spring bronze	Bright tin

Data Sheet 2131

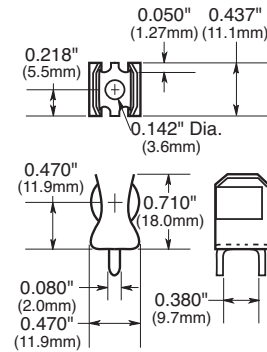

1A5600 Series

PCB Fuseclips for ATC Fuses (0-20A)

Catalog Number	Clip Material	Finish
1A5600	Brass	Satin finish tin

Data Sheet 2131

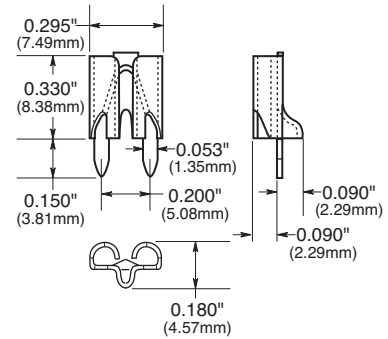

1A5778

PCB Fuseclips for ATM Fuses

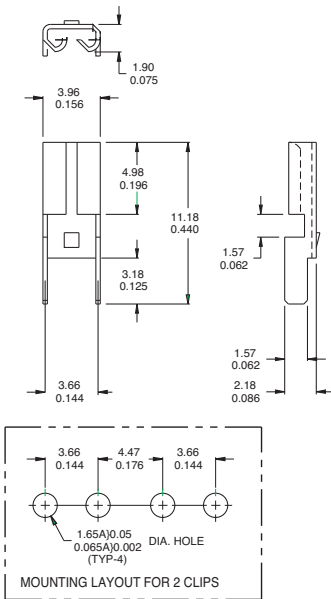

MATERIAL: BRASS, NICKEL PLATED, 0.30 / 0.012 THICK

Data Sheet 2131

1A5779 Series

PCB Fuseclips for ATM Fuses

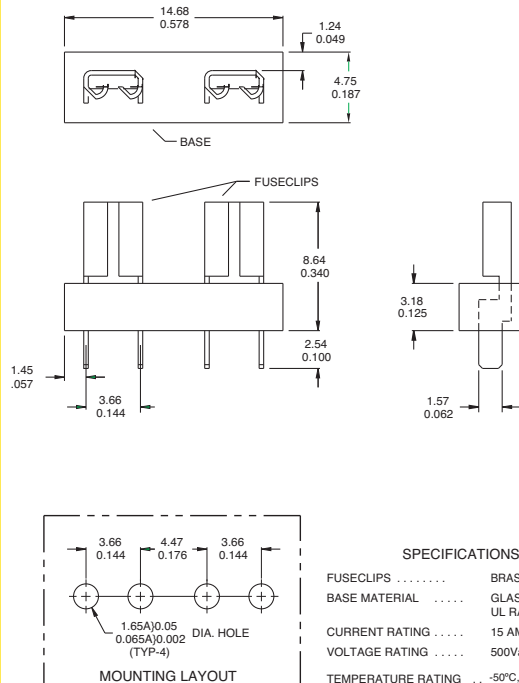

Data Sheet 2131

SPECIFICATIONS

FUSECLIPS	BRASS, NICKEL PLATED
BASE MATERIAL	GLASS FILLED NYLON, UL RATED 94V0
CURRENT RATING	15 AMPS
VOLTAGE RATING	500Vac
TEMPERATURE RATING	-50°C, -58°F TO 145°C, 292°F

1A5780 Series

PCB Fuseclips for ATC Fuses

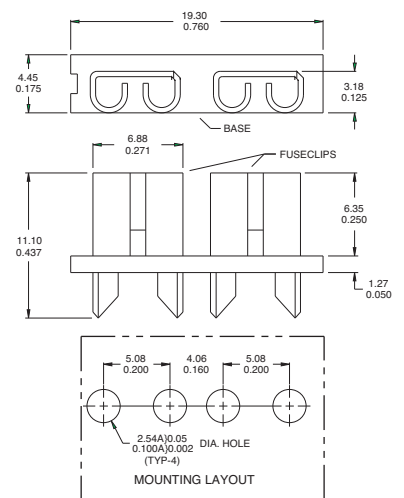

SPECIFICATIONS

FUSECLIPS	BRASS, NICKEL PLATED
BASE MATERIAL	GLASS FILLED NYLON, UL RATED 94V0
CURRENT RATING	15 AMPS
VOLTAGE RATING	500Vac
TEMPERATURE RATING	-50°C, -58°F TO 145°C, 292°F

Data Sheet 2131

PC Board Fuseclips for 1/4", 3/32", 13/32" and 1/6" Diameter Fuses

5681 & 5682 Series

PCB Fuseclips with Mounting Holes For 1/4" Diameter Fuses

Catalog Number	End Stop	Clip Mat.**	Finish	Dimensions (Inches)					Hole Dia.	Ref.
				B (To End Stop)	C (Contact)	D (Height)	E (Width)			
5681-01	No	BeCu	Silver	†	0.265	0.41	0.32	0.132	Fig. 2	
5681-08		Spg. Br.	Nickel							
5681-15-R		Spg. Br.	Bright Tin							
5682-01	Yes	BeCu	Silver	0.108	0.262	0.41	0.32	0.132	Fig. 1	
5682-02		BeCu	Silver							
5682-11-R		BeCu	Bright Tin	0.131						
5682-41-R		Spg. Br.	Bright Tin	0.106						
5682-44-R		Spg. Br.	Bright Tin	0.132						

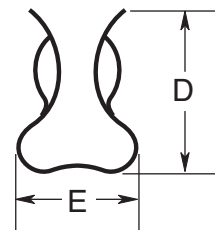
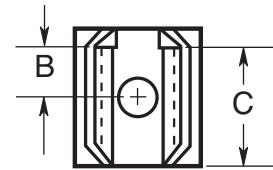

Figure 1

5672 & 5674 Series

PCB Fuseclips with Mounting Holes For 3/32" Diameter Fuses

Catalog Number	End Stop	Clip Mat.**	Finish	Dimensions (Inches)					Hole Dia.	Ref.
				B (To End Stop)	C (Contact)	D (Height)	E (Width)			
5672-11	No	Spg. Br.	Bright Tin	†	0.362	0.52	0.38	0.172	Fig. 2	
5674-01	Yes	BeCu	Silver	0.168	0.356	0.52	0.38	0.172	Fig. 1	
5674-10		BeCu	Bright Tin							
5674-41		Spg. Br.	Bright Tin							



5956 & 5960 Series

PCB Fuseclips with Mounting Holes For 13/32" Diameter Fuses

Catalog Number	End Stop	Clip Mat.**	Finish	Dimensions (Inches)					Hole Dia.	Ref.
				B (To End Stop)	C (Contact)	D (Height)	E (Width)			
5956-16	No	Spg. Br.	Bright Tin	†	0.312	0.71	0.47	0.172	Fig. 2	
5960-07	Yes	BeCu	Silver	0.168	0.387	0.71	0.47	0.196	Fig. 1	
5960-09		BeCu	Silver	0.20				0.172		
5960-44		Spg. Br.	Nickel	0.20				0.197		
5960-51		Spg. Br.	Bright Dip*	0.168				0.196		
5960-53		Spg. Br.	Bright Dip*	0.20				0.172		
5960-61-R		Spg. Br.	Bright Tin	0.168				0.196		
5960-62-R		Spg. Br.	Bright Tin	0.168				0.132		
5960-63-R		Spg. Br.	Bright Tin	0.20				0.172		
5960-64-R		Spr. Br.	Bright Tin	0.20				0.128		

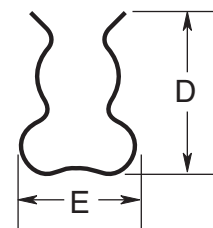
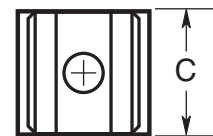

Figure 2

5591 & 5592 Series

PCB Fuseclips with Mounting Holes For 1/6" Diameter Fuses

Catalog Number	End Stop	Clip Mat.**	Finish	Dimensions (Inches)					Hole Dia.	Ref.
				B (To End Stop)	C (Contact)	D (Height)	E (Width)			
5591-42	Yes	Spg. Br.	Bright Dip*	0.26	0.51	0.89	0.60	0.172	Fig. 1	
5591-52-R		Spg. Br.	Bright Tin							
5592-01	No	BeCu	Silver	0.252	0.56	0.875	0.60	0.20	Fig. 2	
5592-11		Spg. Br.	Silver					0.20		



* Bright Dip is actually treated bare metal with no plating.
 ** Spg. Br. — Spring Bronze; BeCu — Beryllium Copper.
 † Hole in center of both clip and contact area.