

## Assembly Instructions

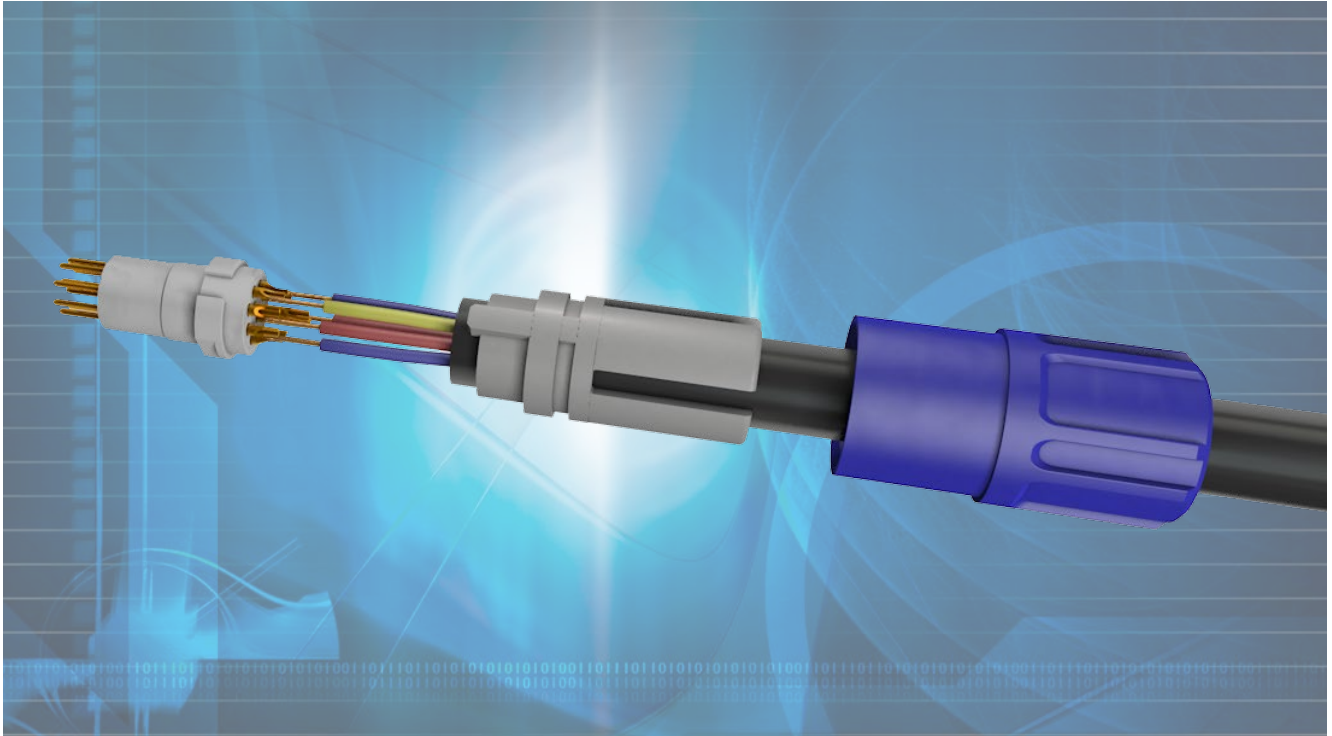

- Straight Plug Size 1**
- Right-angled Plug Size 1**
- In-line Receptacle Size 1**
- Straight Plug Size 2**

## Assembly Straight Plug Size 1

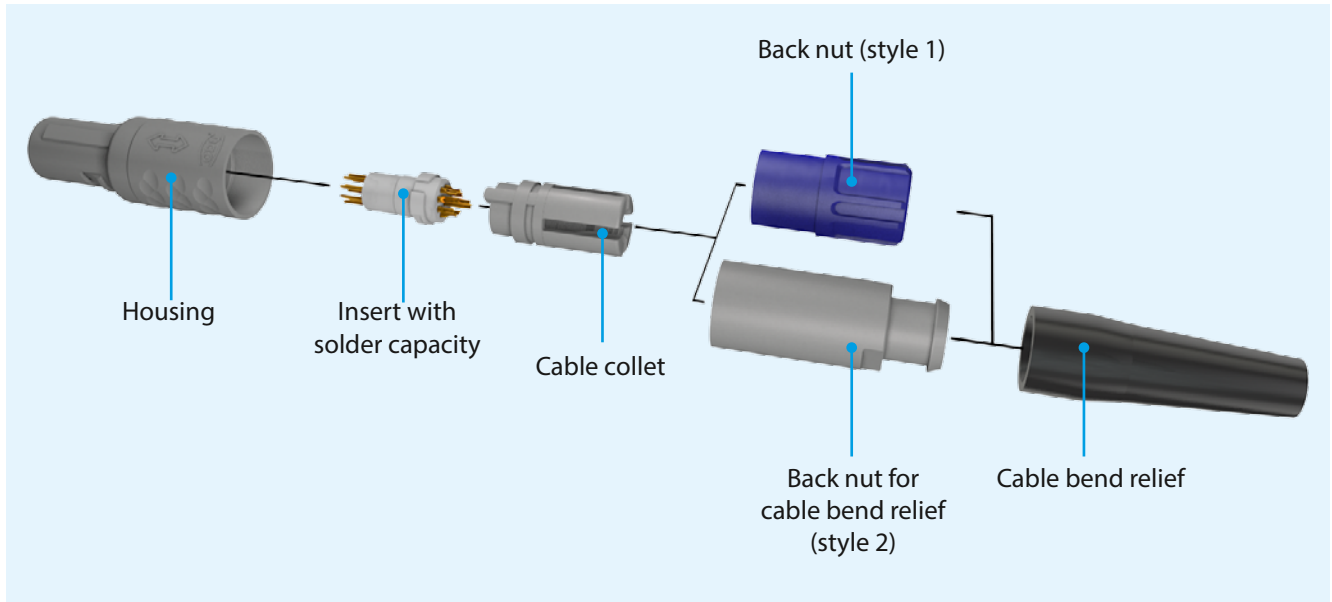

1. Slide back nut and cable collet over the cable.

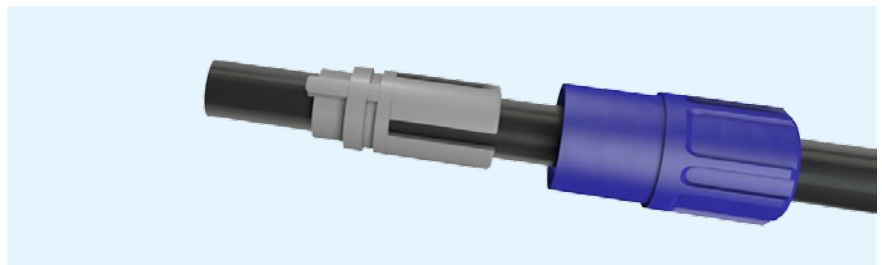

2. Strip cable and wire (see page 10).
3. Pre-tinning of strands.

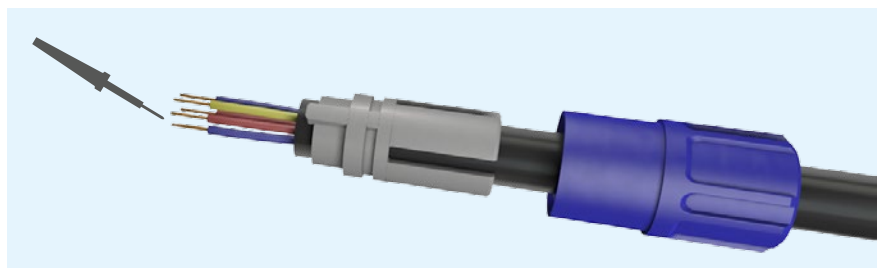

4. Solder the litz wires (A) according to contact arrangement.  
 Recommended cleaning agent:  
 Isopropyl Alcohol.

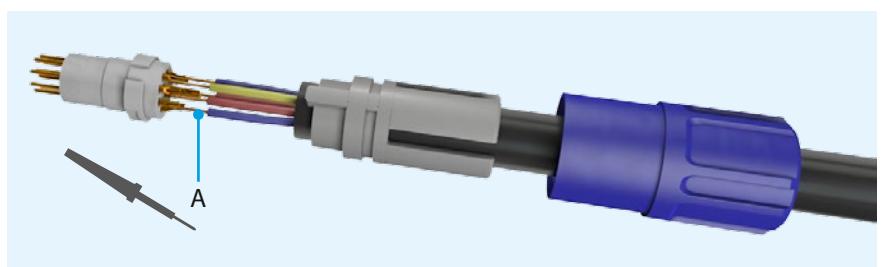

- Slide the cable collet against contact insert.  
 Caution: Don't damage the contacts.

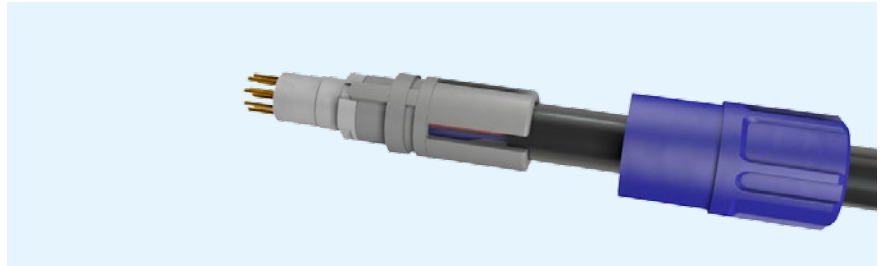

- Put the assembled cable considering the guidings (B) into the housing.

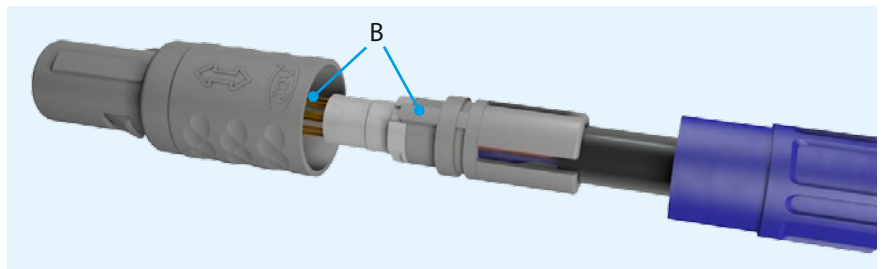

- Screw and fasten back nut on the assembled in-line receptacle.  
 Caution! Consider tightening torque (see page 10).  
 If necessary, secure thread (C) with adhesive (see page 10).  
 The assembly is finished.

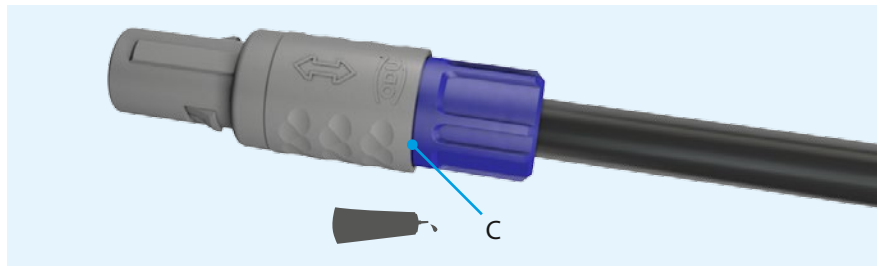

## Assembly Right-angled Plug Size 1

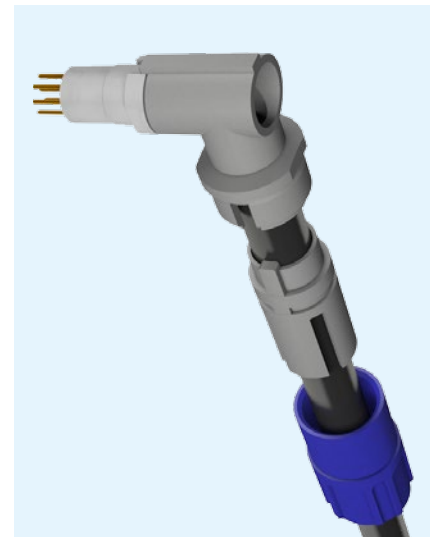
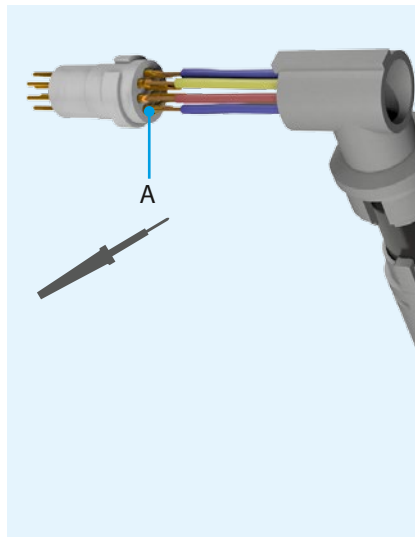
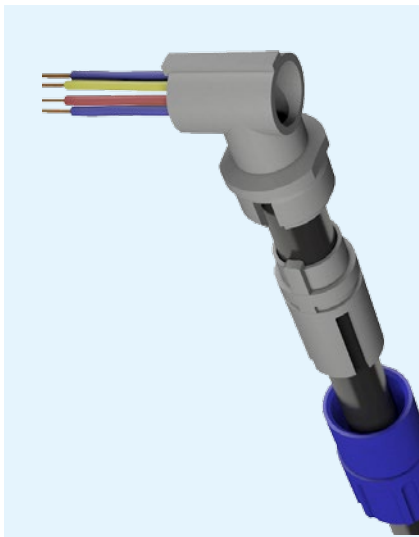
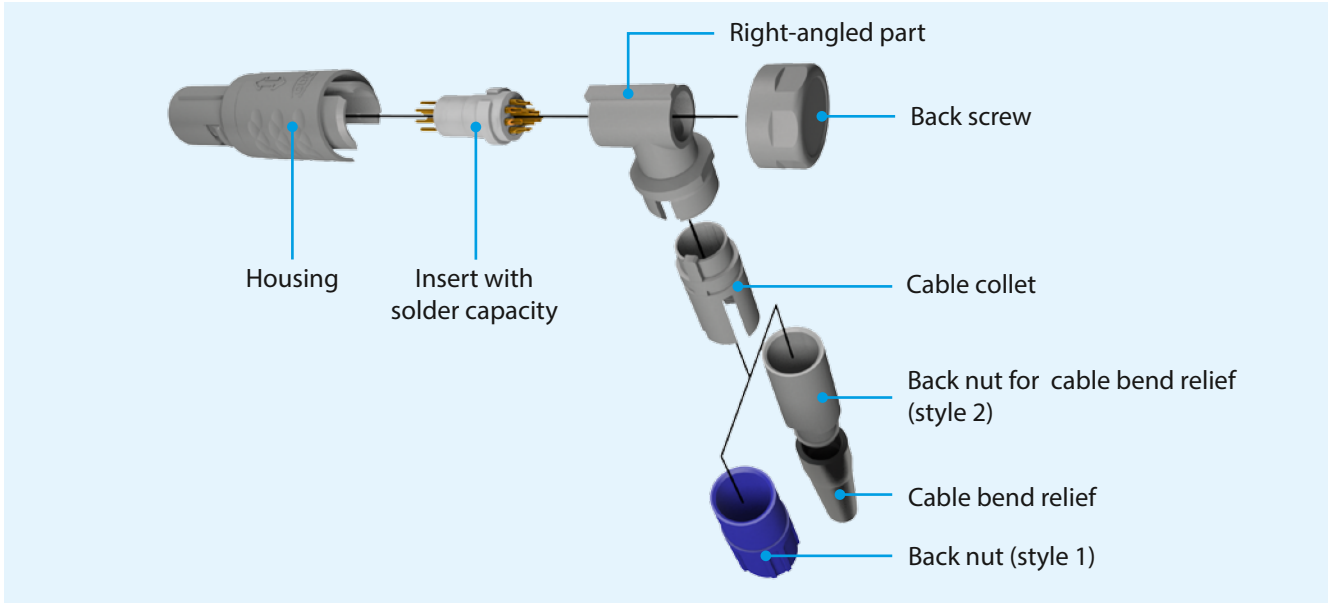

1. Strip cable and wire (see page 10).
2. Slide back nut and cable collet and right-angled part over the cable.
3. Pre-tinning of strands.
4. Solder the litz wires according to contact arrangement.  
 Recommended cleaning agent: Isopropyl Alcohol.
5. Slide the right-angled part against contact insert.  
 Caution: Don't damage the contacts.
6. Slide the cable collet against right-angled part.

7. Slide the assembled cable considering the guidings (B) into the housing. Slide the cable collet into the right-angled part and screw it with the back nut. If necessary, secure thread (C) with adhesive (see page 10). Caution! Consider tightening torque (see page 10).

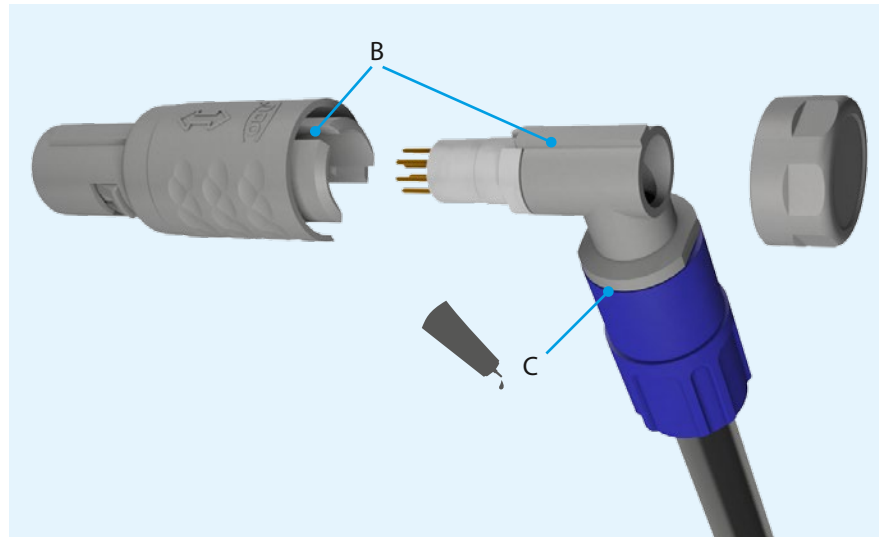

8. Screw back screw on the assembled plug and fasten it with ODU spanner wrench (D). If necessary, secure thread (E) with adhesive (see page 10). The assembly is finished.

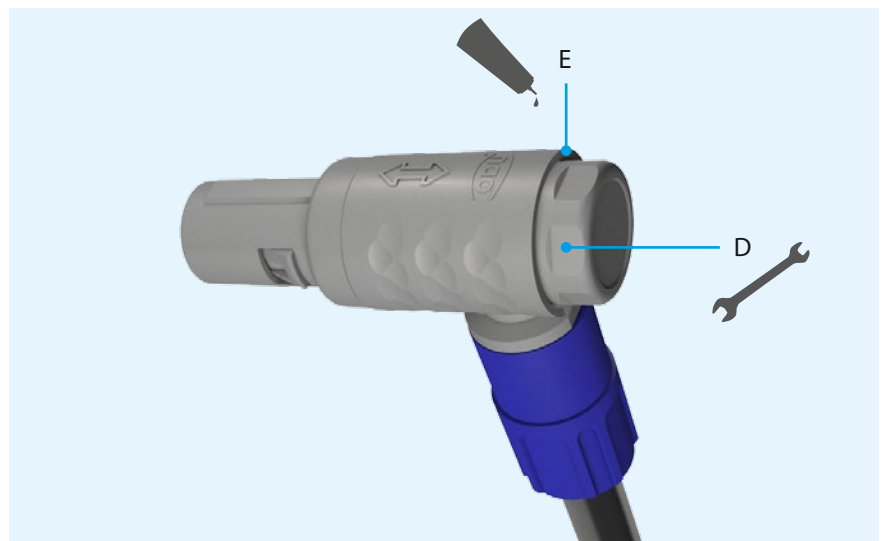

## Assembly In-line Receptacle Size 1

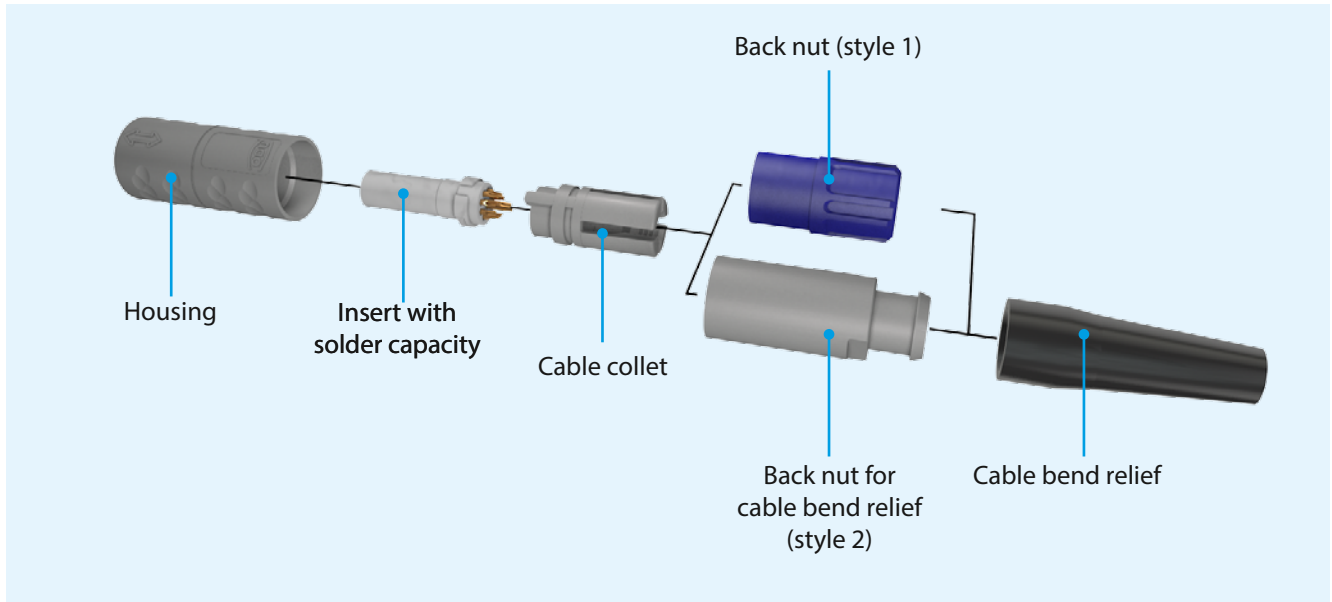

1. Slide back nut and cable collet over the cable.

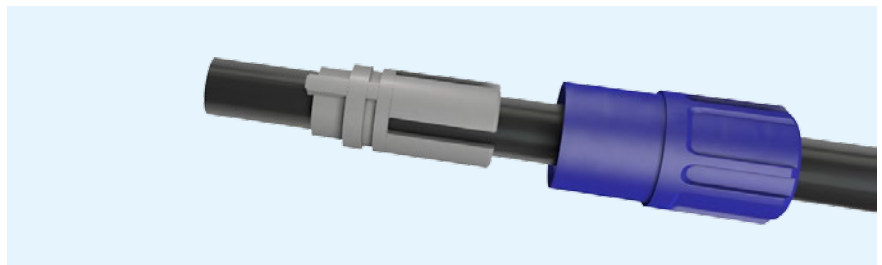

2. Strip cable and wire (see page 10).
3. Pre-tinning of strands.

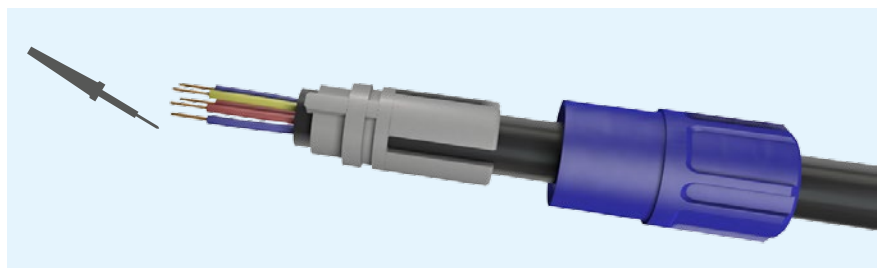

4. Solder the litz wires (A) according to contact arrangement.  
 Recommended cleaning agent:  
 Isopropyl Alcohol.

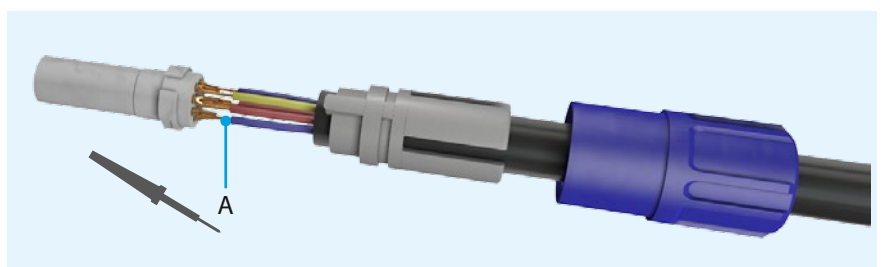

5. Slide the cable collet against contact insert.  
Caution: Don't damage the contacts.

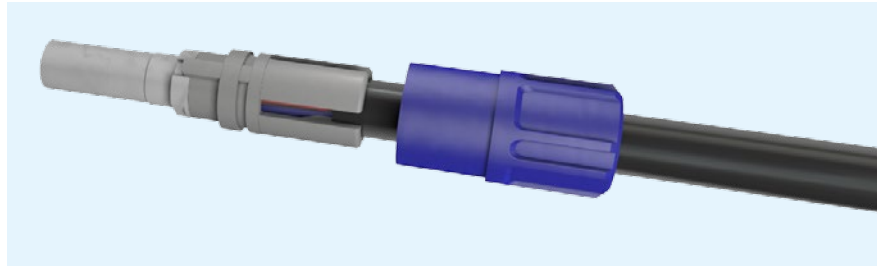

6. Put the assembled cable considering the guidings (B) into the housing.

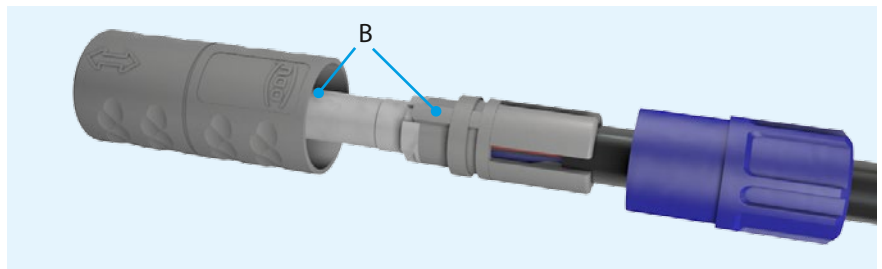

7. Screw and fasten back nut on the assembled in-line receptacle.  
Caution! Consider tightening torque (see page 10).  
If necessary, secure thread (C) with adhesive (see page 10).  
The assembly is finished.

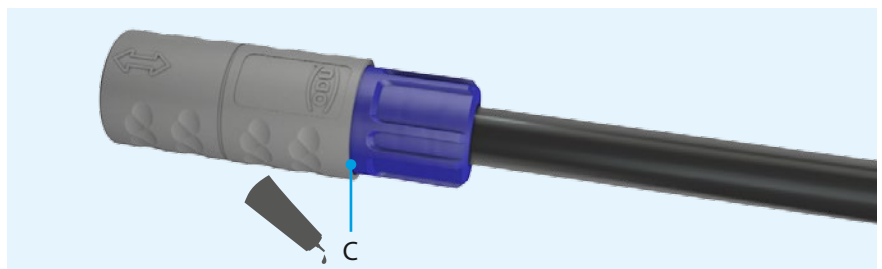

## Assembly Straight Plug Size 2

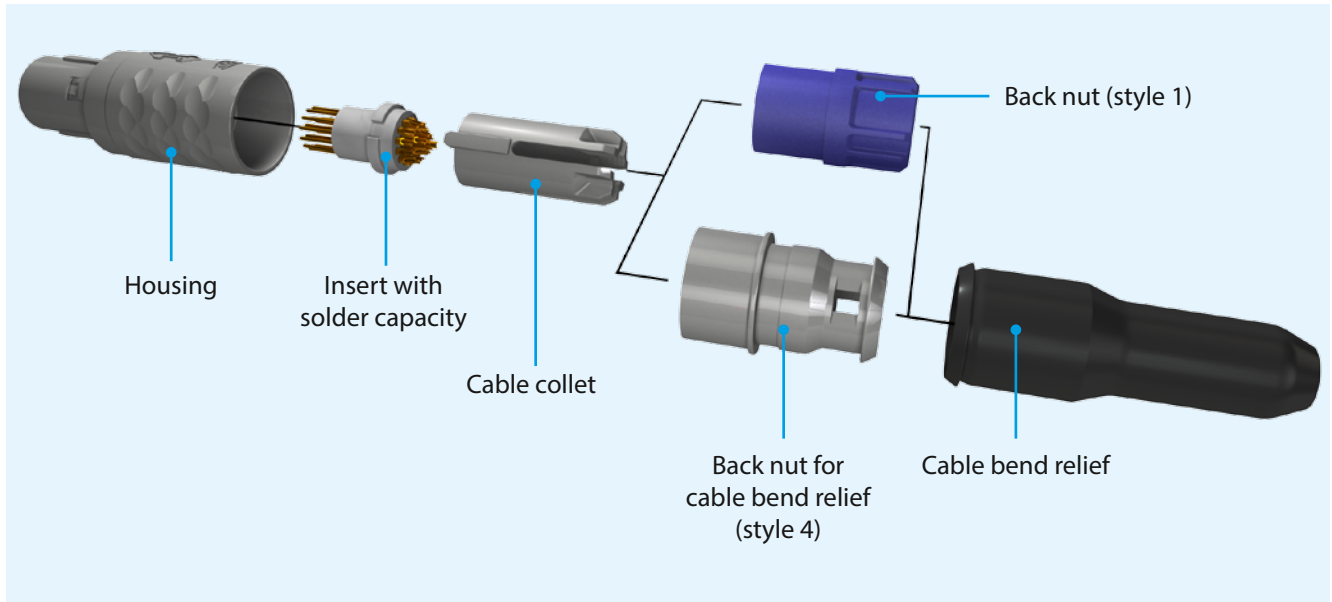

1. Slide back nut and cable collet over the cable.

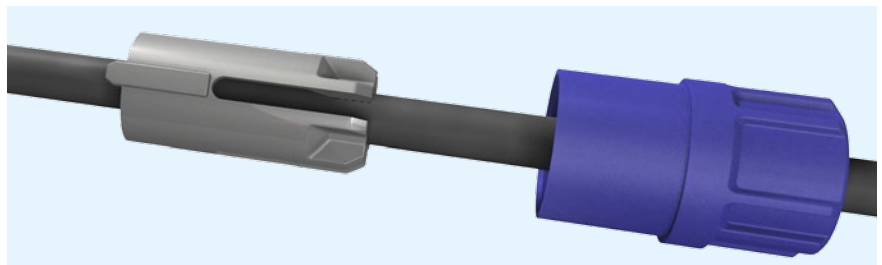

2. Strip cable and wire (see page 10).
3. Pre-tinning of strands.



4. Solder the litz wires (A) according to contact arrangement.  
 Recommended cleaning agent:  
 Isopropyl Alcohol.

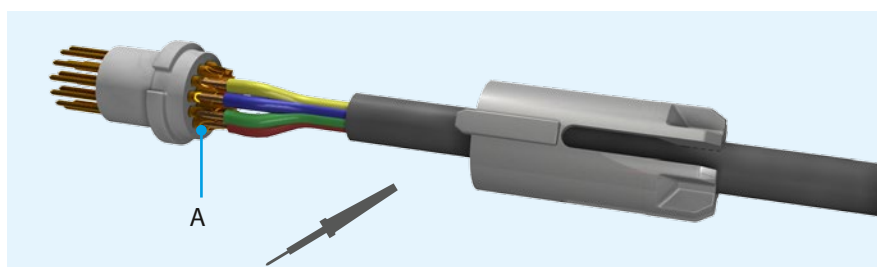



5. Slide the cable collet against contact insert.  
Caution: Don't damage the contacts.

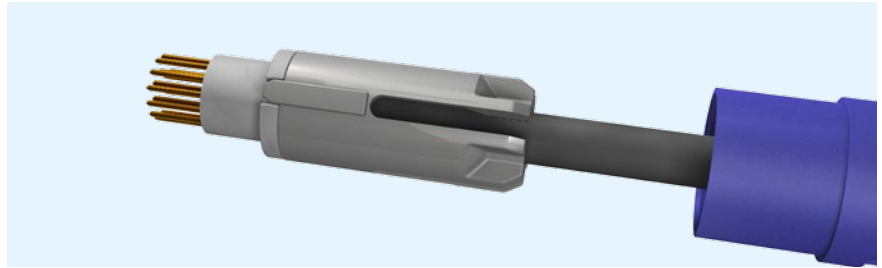

6. Put the assembled cable considering the guidings (B) into the housing.

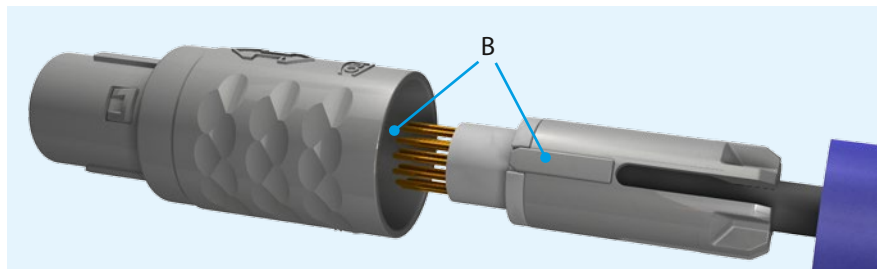

7. Screw and fasten back nut on the assembled in-line receptacle.  
Caution! Consider tightening torque (see page 10).  
If necessary, secure thread (C) with adhesive (see page 10).  
The assembly is finished.

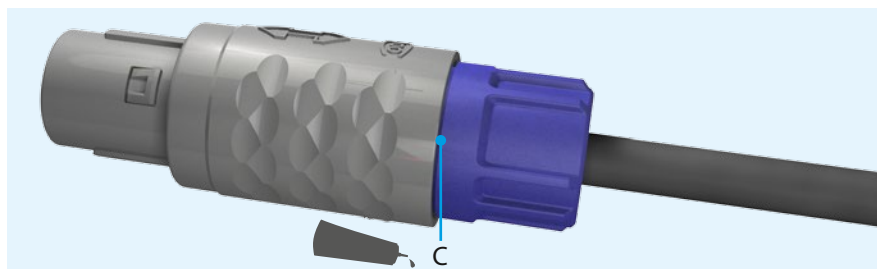

## Notes

### 1. Recommended stripping length

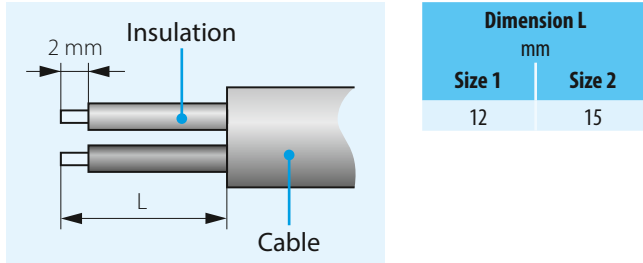

### 2. Tightening torque

	Torque moment	Torque moment
	Size 1	Size 2
	Nm	Nm
Straight plug	0.25	0.5
Right-angled plug clamping cap	0.30	–
Right-angled plug clamping nut	0.25	–
In-line receptacle	0.25	–

### 3. Recommended adhesive for the back nut

Scotchweld (grey), ODU part number 890.204.000.030.025  
 Recommended cleaning agent: Isopropyl alcohol.  
 Caution! If adhesives that have not been released are used, cracks may appear after some time. Use only the indicated adhesive.

### 4. Tools/Accessories

- ODU open-ended spanner see [ODU MEDI-SNAP product catalogue](#) section accessories and tools
- ODU crimping tool see [ODU MEDI-SNAP product catalogue](#) section accessories and tools.