

---

## Micropower high precision series voltage reference

---

Datasheet - production data



### Features

- Fixed 1.25 V, 1.8 V, 2.048 V, 2.5 V, 3.0 V, 3.3 V, 4.096 V, 5.0 V output voltage
- Ultra low operating current: 3.9  $\mu\text{A}$  (typ.) at 25 °C
- High initial accuracy: +/-0.15 %
- Stable when used with capacitive loads
- Extended temperature range: -40 to +125 °C
- 30 ppm/°C maximum temperature coefficient
- Available in QFN8 1.5x1.5 package

### Applications

- Portable equipment
- Data acquisition systems
- Instrumentation
- Medical equipment
- Test equipment

### Description

The TS33 family of low power series voltage references is capable of providing stable and precise output voltages with an initial accuracy of 0.15 % over an extended temperature range (-40 to +125 °C).

The ultra low operating current is a key advantage for power-restricted designs. In addition, the TS33 is very stable over the entire operating temperature range, making it suitable for high-precision applications.

Available in QFN8 surface mount packages, the TS33 can be designed in applications where space saving is a critical issue.

---

**Contents**

<b>1</b>	<b>Pin configuration .....</b>	<b>3</b>
<b>2</b>	<b>Maximum ratings .....</b>	<b>4</b>
<b>3</b>	<b>Electrical characteristics .....</b>	<b>5</b>
<b>4</b>	<b>Typical performance characteristics .....</b>	<b>7</b>
<b>5</b>	<b>Package information .....</b>	<b>10</b>
	5.1    QFN8 package information .....	10
<b>6</b>	<b>Ordering information.....</b>	<b>13</b>
<b>7</b>	<b>Revision history .....</b>	<b>14</b>

# 1 Pin configuration

Figure 1: Pin configuration (top view)

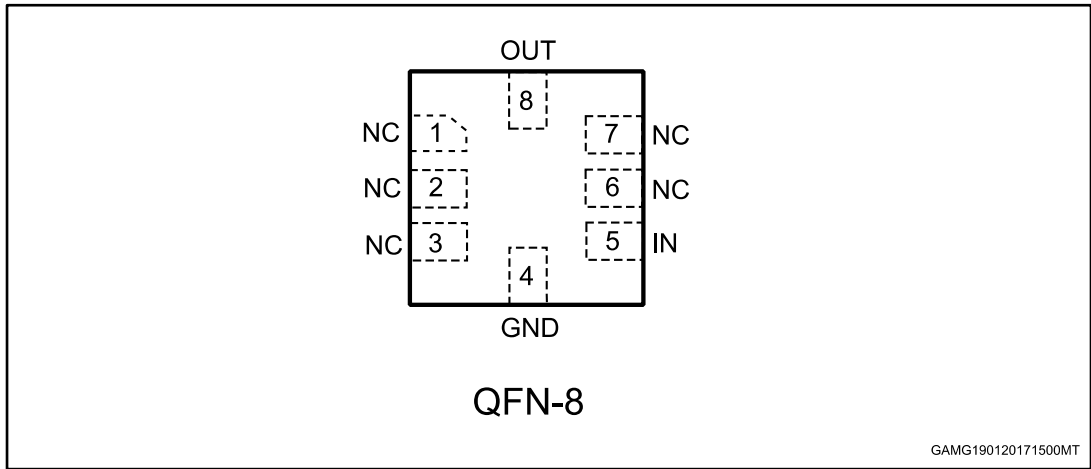

## 2 Maximum ratings

Table 1: Absolute maximum ratings

Symbol	Parameter	Value	Unit
$V_{IN}$	Maximum input voltage	-0.3 to 7	V
$V_{OUT}$	Maximum voltage on the output pin	-0.3 to $V_{IN} + 0.3$	V
$I_{OUT}$	Output short-circuit current (sinking/sourcing)	Internally limited	mA
$P_d$	Power Dissipation <sup>(1)</sup>	700	mW
$T_{stg}$	Storage temperature	-65 to +150	°C
ESD	Human body model (HBM)	4	kV
	Charged device model	1000	V
$T_{lead}$	Lead temperature (soldering) 10 s	260	°C
$T_j$	Max junction temperature	+150	°C

**Notes:**

<sup>(1)</sup> $P_d$  has been calculated with  $T_{amb} = 25\text{ °C}$  and  $T_{jmax} = 150\text{ °C}$ .



Absolute maximum ratings are those values beyond which damage to the device may occur. Functional operation under these conditions is not implied.

Table 2: Thermal data

Symbol	Parameter	Value	Unit
$R_{thJA}$	Thermal resistance junction-ambient	159	°C/W
$R_{thJC}$	Thermal resistance junction-case	103	°C/W

Table 3: Recommended operating conditions

Symbol	Parameter	Value	Unit
$V_{IN}$	Operating input voltage range	1.8 to 5.5	V
$I_{OUT}$	Maximum operating current	±5	mA
$T_{oper}$	Operating free air temperature range	-40 to +125	°C

### 3 Electrical characteristics

$V_{IN} = 5\text{ V}$ ,  $I_{LOAD} = 0\text{ mA}$ ,  $T_{amb} = 25\text{ °C}$  (unless otherwise specified).

**Table 4: Electrical characteristics for TS3312**

Symbol	Parameter	Test condition	Min.	Typ.	Max.	Unit
$V_{IN}$	Minimum input voltage	$I_{LOAD} = 0\text{ mA}$ $T_{amb} = 25\text{ °C}$	1.8			V
$V_{OUT}$	Output voltage	$V_{IN} = 5\text{ V}$ $I_{LOAD} = 0\text{ mA}$ $T_{amb} = 25\text{ °C}$		1.25		V
	Initial accuracy		-0.15		0.15	%
$\Delta V_{OUT}/\Delta T$	Average temperature coefficient	$-40\text{ °C} < T_{amb} < +85\text{ °C}$		9	30	ppm/°C
		$-40\text{ °C} < T_{amb} < +125\text{ °C}$		8	30	
$\Delta V_{OUT}/\Delta V_{IN}$	Line regulation	$V_{IN} = 1.8\text{ V to } 5.5\text{ V}$	-50	6	+50	ppm/V
		$0\text{ °C} < T_{amb} < 70\text{ °C}$		6		
		$-40\text{ °C} < T_{amb} < +85\text{ °C}$		8		
		$-40\text{ °C} < T_{amb} < +125\text{ °C}$		30		
$\Delta V_{OUT}/\Delta I_{LOAD}$	Load regulation	$V_{IN} = 1.8\text{ V}$	-50	6	+50	ppm/mA
		$I_{LOAD} = \pm 5\text{ mA}$ $0\text{ °C} < T_{amb} < 70\text{ °C}$		10		
		$-40\text{ °C} < T_{amb} < +85\text{ °C}$		20		
		$-40\text{ °C} < T_{amb} < +125\text{ °C}$		20		
$I_{SC}$	Short-circuit current sourcing/sinking			35		mA
$I_Q$	Quiescent current			3.9	7	$\mu\text{A}$
		$-40\text{ °C} < T_{amb} < +85\text{ °C}$		4.4	7.5	
		$-40\text{ °C} < T_{amb} < +125\text{ °C}$		4.8	10	
$C_{OUT}$	Capacitive load		0.1		10	$\mu\text{F}$
$T_{ON}$	Turn-on settling time	to 0.1 %, $C_{OUT} = 1\text{ }\mu\text{F}$		2		ms
$e_n$	Noise floor	$f = 0.1\text{ Hz to } 10\text{ Hz}$		35		$\mu\text{V}_{P-P}$

Table 5: Electrical characteristics for TS3330

Symbol	Parameter	Test conditions	Min.	Typ.	Max.	Unit
$V_{OUT}$	Output voltage	$V_{IN} = 5\text{ V}$		3.0		V
	Initial accuracy	$I_{LOAD} = 0\text{ mA}$ $T_{amb} = 25\text{ °C}$	-0.15		0.15	%
$\Delta V_{OUT}/\Delta T$	Average temperature coefficient	$-40\text{ °C} < T_{amb} < +85\text{ °C}$		9	30	ppm/°C
		$-40\text{ °C} < T_{amb} < +125\text{ °C}$		8	30	
$\Delta V_{OUT}/\Delta V_{IN}$	Line regulation	$V_{IN} = 3.2\text{ V to } 5.5\text{ V}$	-50	6	+50	ppm/V
		$0\text{ °C} < T_{amb} < 70\text{ °C}$		6		
		$-40\text{ °C} < T_{amb} < +85\text{ °C}$		8		
		$-40\text{ °C} < T_{amb} < +125\text{ °C}$		30		
$\Delta V_{OUT}/\Delta I_{LOAD}$	Load regulation	$V_{IN} = 3.2\text{ V}$	-50	6	+50	ppm/mA
		$I_{LOAD} = \pm 5\text{ mA}$ $0\text{ °C} < T_{amb} < 70\text{ °C}$		10		
		$-40\text{ °C} < T_{amb} < +85\text{ °C}$		20		
		$-40\text{ °C} < T_{amb} < +125\text{ °C}$		20		
$V_{DROP}$	Minimum dropout voltage	$V_{IN} = 3.2\text{ V}$ $I_{LOAD} = \pm 5\text{ mA}$		50	100	mV
		$0\text{ °C} < T_{amb} < 70\text{ °C}$		70		
		$-40\text{ °C} < T_{amb} < +85\text{ °C}$		75		
		$-40\text{ °C} < T_{amb} < +125\text{ °C}$		80		
		$I_{LOAD} = \pm 2\text{ mA}$ $-40\text{ °C} < T_{amb} < +85\text{ °C}$			70	
$I_{SC}$	Short-circuit current sourcing/sinking			35		mA
$I_Q$	Quiescent current			3.9	7	$\mu\text{A}$
		$-40\text{ °C} < T_{amb} < +85\text{ °C}$		4.4	7.5	
		$-40\text{ °C} < T_{amb} < +125\text{ °C}$		4.8	10	
$C_{OUT}$	Capacitive load		0.1		10	$\mu\text{F}$
$T_{ON}$	Turn-on settling time	to 0.1 %, $C_{OUT} = 1\text{ }\mu\text{F}$		2		ms
$e_n$	Noise floor	$f = 0.1\text{ Hz to } 10\text{ Hz}$		67		$\mu\text{V}_{P-P}$

## 4 Typical performance characteristics

The following plots are referred to the typical application circuit and, unless otherwise noted, at  $T_A = 25\text{ }^\circ\text{C}$ ,  $V_{OUT} = 3.0\text{ V}$ .

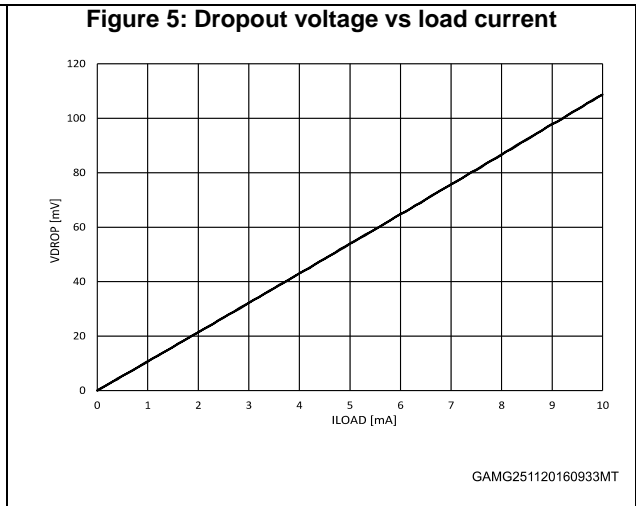
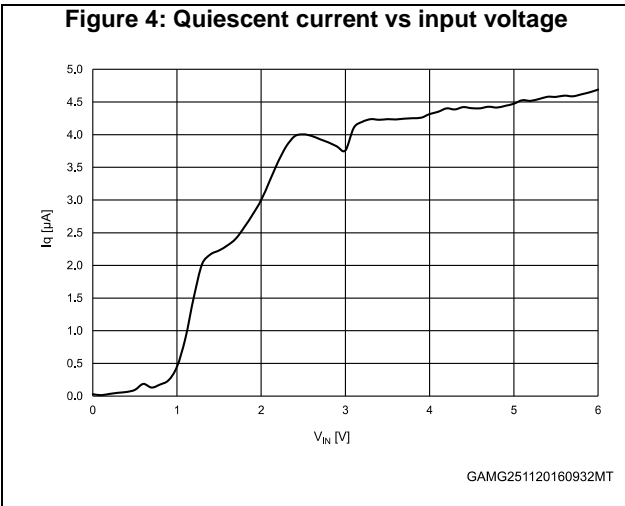
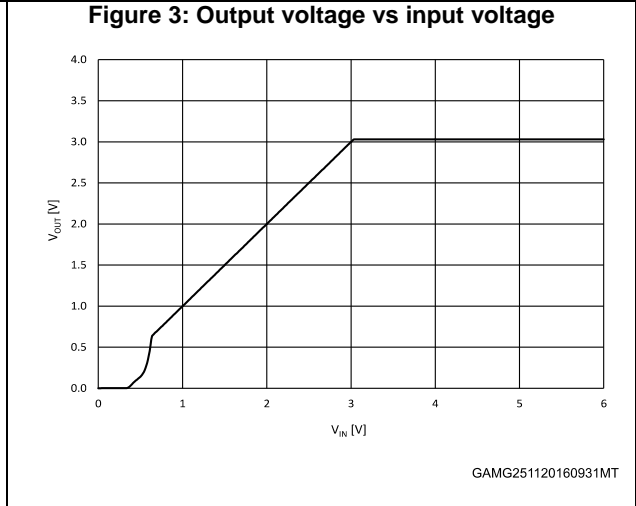
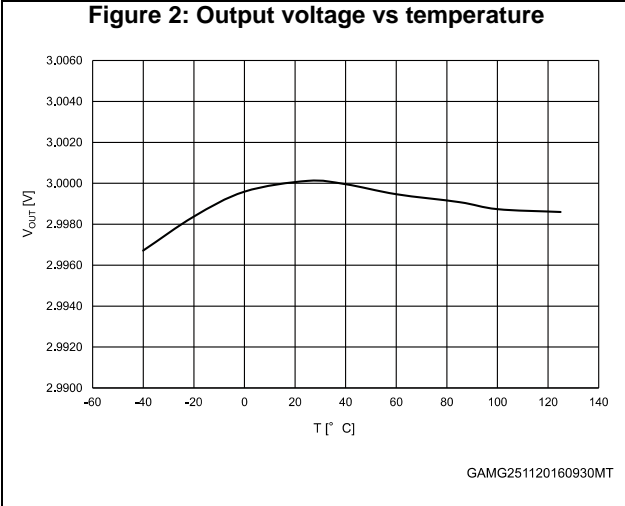

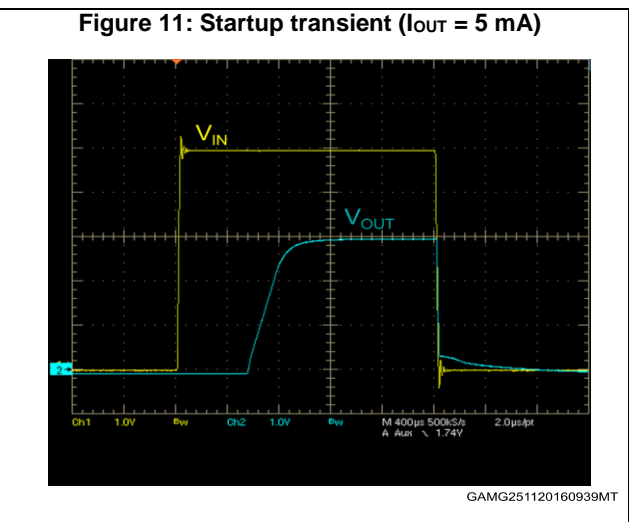
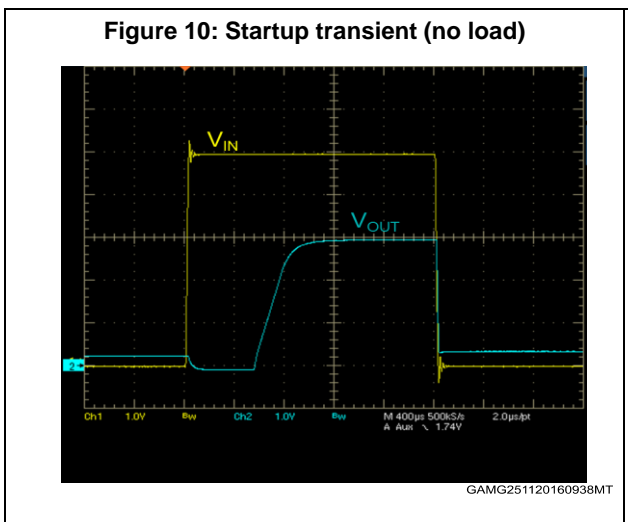
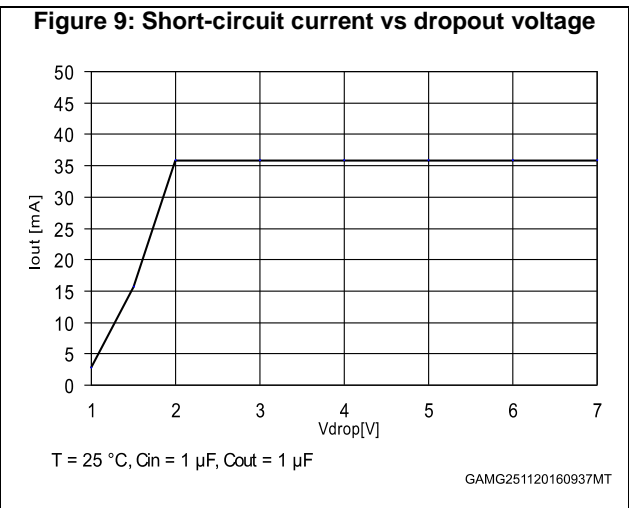
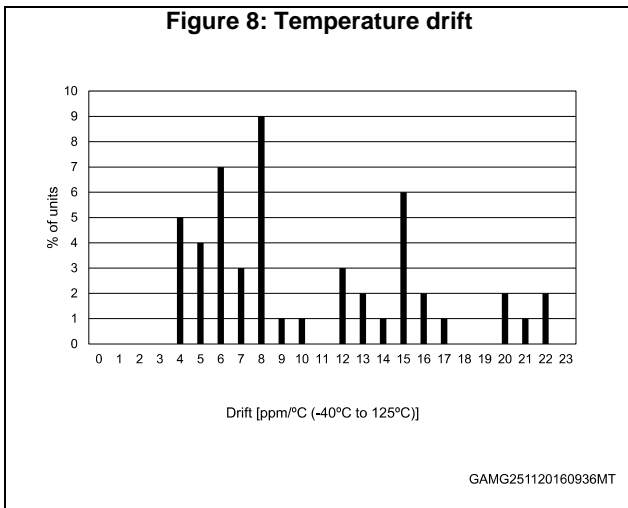
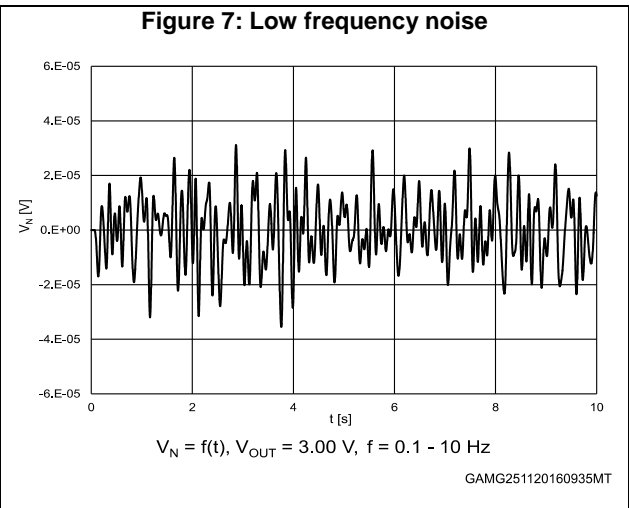
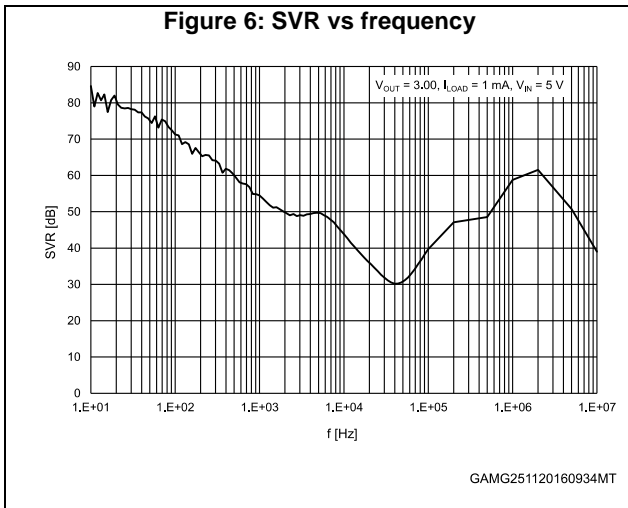

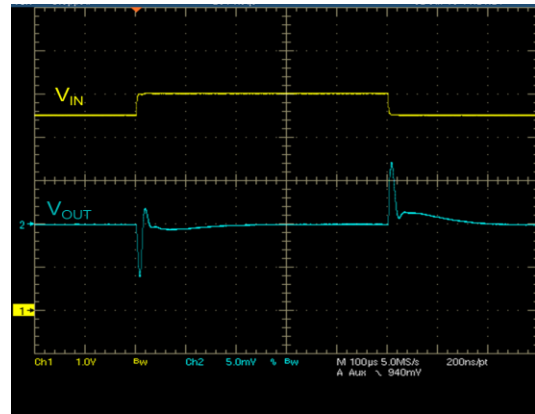

Figure 12: Line transient (no load)



GAMG251120160940MT

Figure 13: Line transient ( $I_{OUT} = 1\text{ mA}$ )



GAMG251120160941MT

Figure 14: Load transient ( $I_{OUT} = \pm 1\text{ mA}$ )

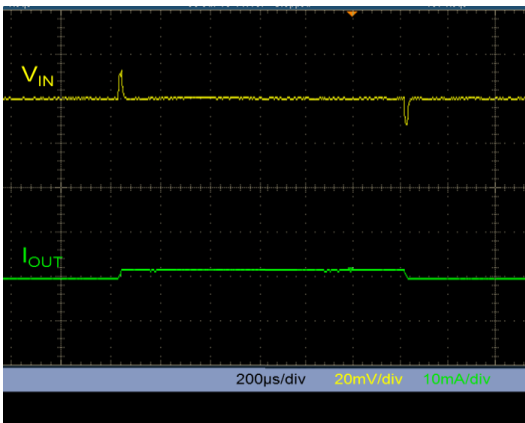

GAMG251120160942MT

Figure 15: Load transient ( $I_{OUT} = \pm 5\text{ mA}$ )

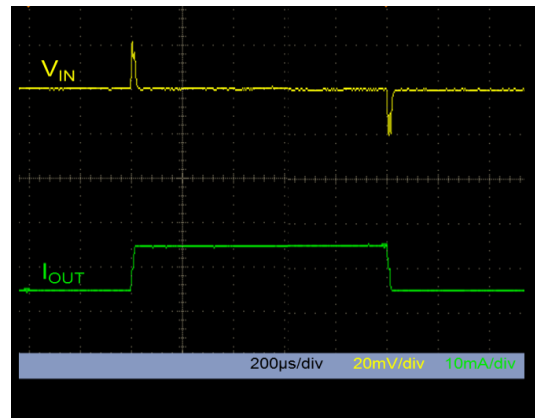

GAMG251120160943MT

Figure 16: Short-circuit response

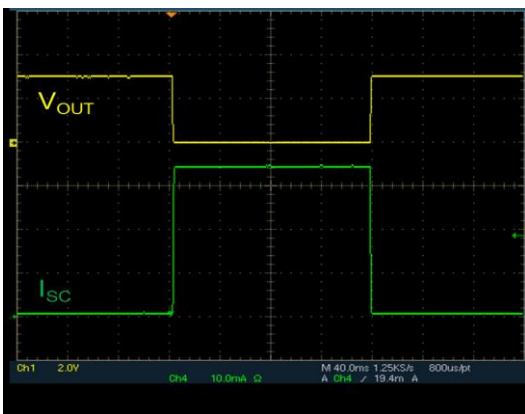

GAMG251120160944MT

Figure 17: Stability plan

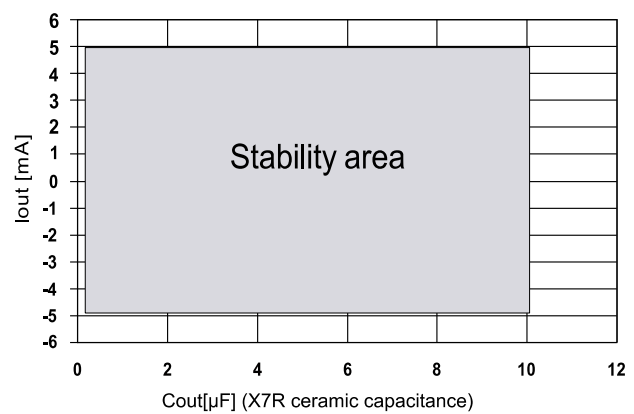

GAMG251120160945MT

## 5 Package information

In order to meet environmental requirements, ST offers these devices in different grades of ECOPACK® packages, depending on their level of environmental compliance. ECOPACK® specifications, grade definitions and product status are available at: [www.st.com](http://www.st.com). ECOPACK® is an ST trademark.

### 5.1 QFN8 package information

Figure 18: QFN8 package outline

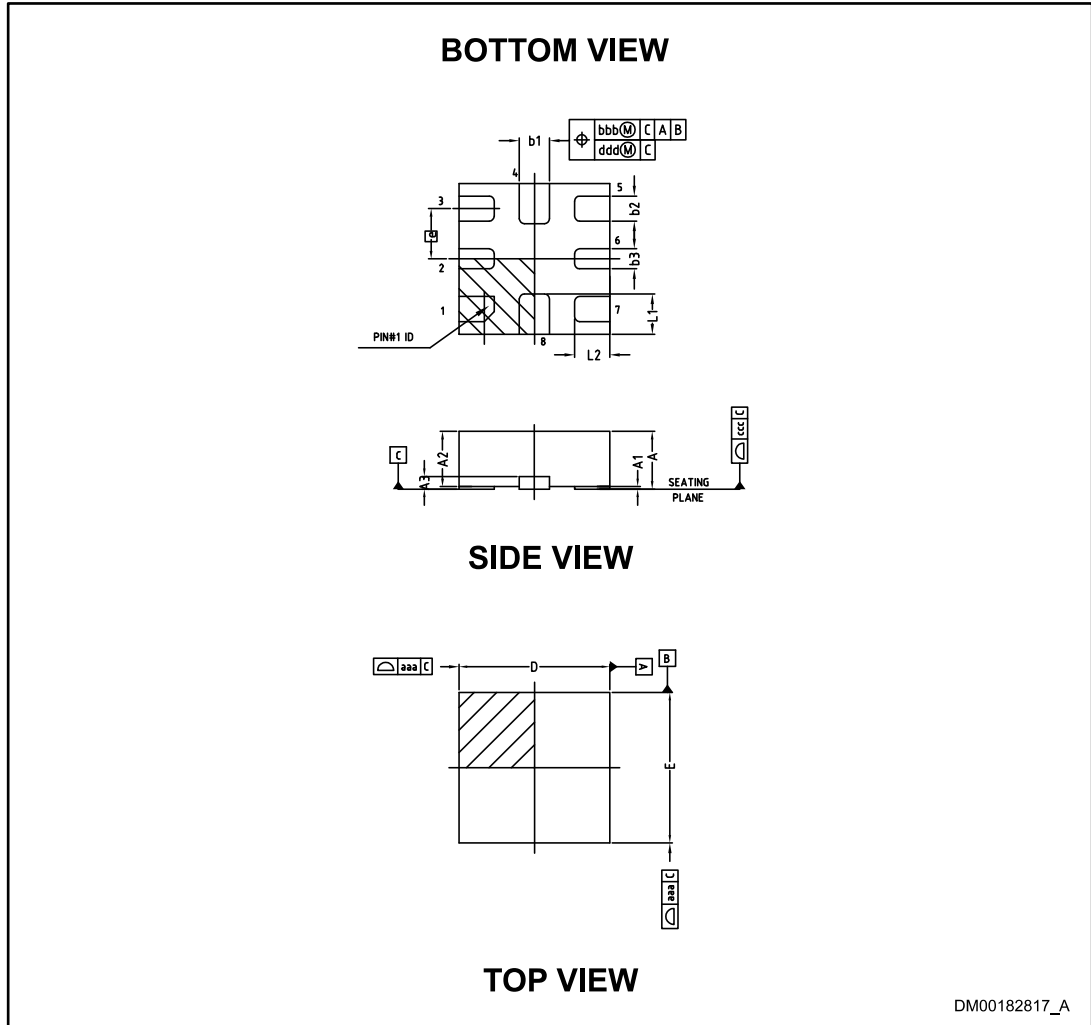

Table 6: QFN8 mechanical data

Dim.	mm			Note
	Min.	Typ.	Max.	
A	0.40	-	0.55	4
A1	0.00	-	0.05	12
A2	0.33	0.43	0.53	4
A3		-		4
b1	0.25	0.3	0.35	4.9
b2	0.20	0.25	0.30	
b3	0.15	0.20	0.25	
D	1.40	1.50	1.60	4
e		0.50		4
E	1.40	1.50	1.60	4
L1	0.30	0.40	0.50	4
L2	0.25	0.35	0.45	4
N	8			15

Table 7: QFN8 tolerance of form and position

Symbol	Tolerance of form and position
aaa	0.15
bbb	0.10
ccc	0.08
ddd	0.05
eee	0.10
Note	1.4
Ref	

Figure 19: QFN8 recommended footprint

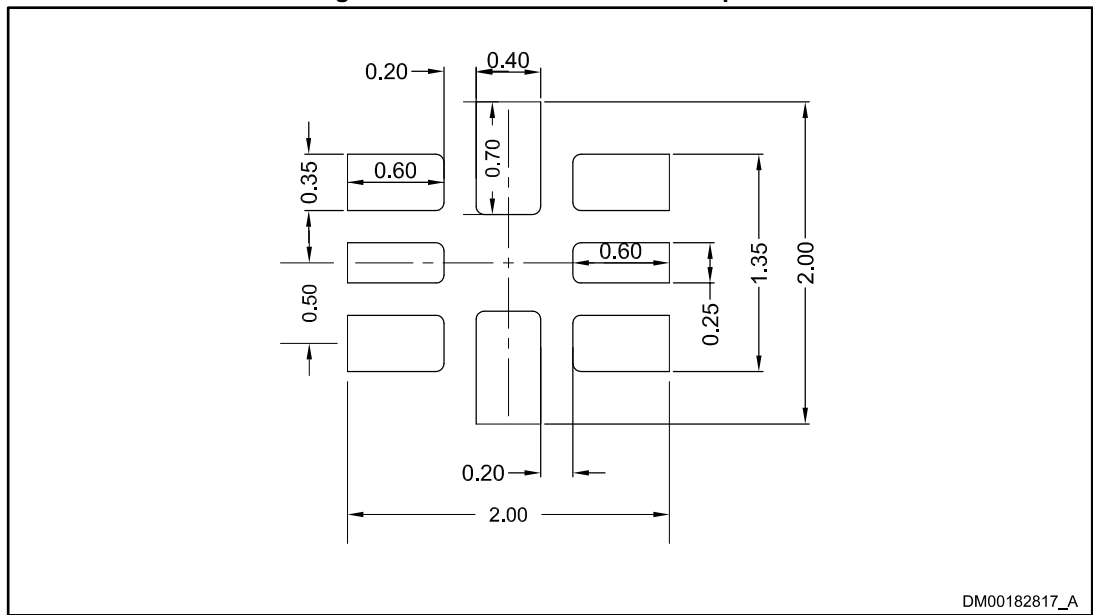

## 6 Ordering information

Table 8: Order codes

Part number	Output voltage (V)	Precision	Package	Temperature range
TS3312AQPR <sup>(1)</sup>	1.25	+/-0.15 %	QFN8	-40 to +125 °C
TS3330AQPR	3.0	+/-0.15 %		

**Notes:**

<sup>(1)</sup>Available on request.

## 7 Revision history

Table 9: Document revision history

Date	Revision	Changes
05-Sep-2017	1	Initial release.

**IMPORTANT NOTICE – PLEASE READ CAREFULLY**

STMicroelectronics NV and its subsidiaries ("ST") reserve the right to make changes, corrections, enhancements, modifications, and improvements to ST products and/or to this document at any time without notice. Purchasers should obtain the latest relevant information on ST products before placing orders. ST products are sold pursuant to ST's terms and conditions of sale in place at the time of order acknowledgement.

Purchasers are solely responsible for the choice, selection, and use of ST products and ST assumes no liability for application assistance or the design of Purchasers' products.

No license, express or implied, to any intellectual property right is granted by ST herein.

Resale of ST products with provisions different from the information set forth herein shall void any warranty granted by ST for such product.

ST and the ST logo are trademarks of ST. All other product or service names are the property of their respective owners.

Information in this document supersedes and replaces information previously supplied in any prior versions of this document.

© 2017 STMicroelectronics – All rights reserved