

FLUKE®

Fluke 434/435

Three Phase Power Quality Analyzer

Getting Started

EN

April 2006, Rev. 1, Nov. 2007

© 2006, 2007 Fluke Corporation, All rights reserved. Printed in The Netherlands
All product names are trademarks of their respective companies.

Contents of Analyzer Kit

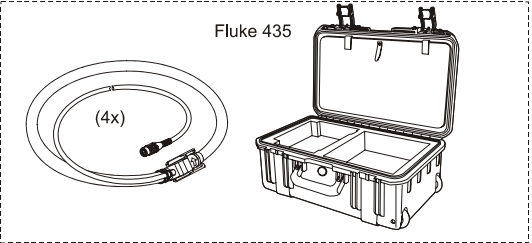
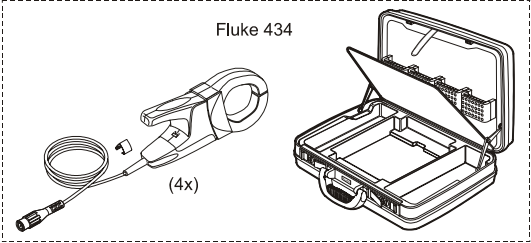
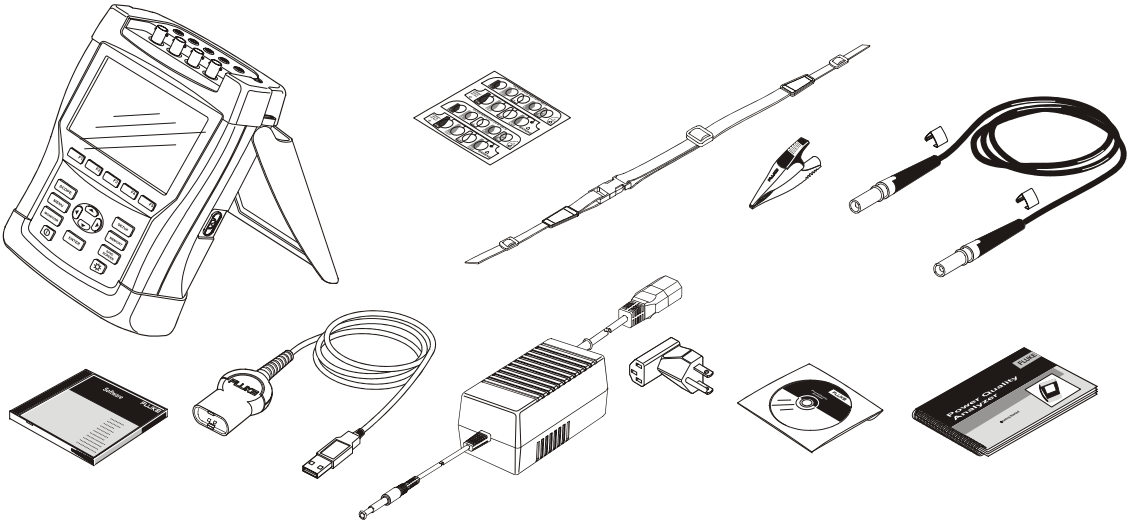

Getting Started

Introduction

This Getting Started manual provides basic information on the Fluke 434 and 435 Three Phase Power Quality Analyzers.

Fluke 435 has additional features such as Mains Signaling, Logging, 0.1 % voltage input accuracy acc. to IEC61000-4-30 2003 Class A, extra memory to store Logging data, Power Log software, flexible current clamps, and a heavy duty trolley style case.

For complete operating instructions, refer to the *Users Manual* on the accompanying CD-ROM.

Contacting a Service Center

To locate a Fluke authorized service center, visit us on the World Wide Web at: www.fluke.com or call Fluke using any of the following phone numbers:
+1-888-993-5853 in the U.S. and Canada

+31-40-2675200 in Europe
+1-425-446-5500 from other countries.

Safety Information: Read First

The Fluke 434/435 Three Phase Power Quality Analyzer - hereafter referred to as “Analyzer” - complies with: IEC/EN61010-1-2001, CAN/CSA C22.2 No 61010-1-04 (including cCSA_{us} approval),

UL std No 61010-1, Safety Requirements for Electrical Equipment for Measurement, Control and Laboratory Use, Part 1: General requirements, Rated: 600V CAT IV 1000V CAT III Pollution Degree 2.

Use the Analyzer and its accessories only as specified in the *Users Manual*. Otherwise, the protection provided by the Analyzer and its accessories might be impaired.

A **Warning** identifies conditions and actions that pose hazard(s) to the user.

A **Caution** identifies conditions and actions that may damage the Analyzer.

⚠ Warning

To avoid electrical shock or fire:

- Review the entire manual before use of the Analyzer and its accessories.
- Avoid working alone.
- Do not operate the Analyzer around explosive gas or vapor.
- Use only insulated current probes, test leads and adapters as supplied with the Analyzer, or indicated as suitable for the Fluke 434/435 Analyzer.
- Before use, inspect the Analyzer, voltage probes, test leads and accessories for mechanical damage and replace when damaged. Look for cracks or missing plastic. Pay special attention to the insulation surrounding the connectors.
- Remove all probes, test leads and accessories that are not in use.
- Always connect the Battery Charger / Power Adapter first to the AC outlet before connecting it to the Analyzer.
- Use the ground input only to ground the Analyzer and do not apply any voltage.

- Do not apply input voltages above the rating of the instrument.
- Do not apply voltages in excess of the marked ratings of the voltage probes or current clamps.
- Take special care during fitting and removal of the flexible current probe: de-energize the installation under test or wear suitable protective clothing.
- Do not use exposed metal BNC or banana plug connectors.
- Do not insert metal objects into connectors.
- Use only the power supply, Model BC430 (Battery Charger / Power Adapter).
- Before use check that the selected/indicated voltage range on the BC430 matches the local line power voltage and frequency. If necessary set the slider switch of the BC430 to the correct voltage.
- For the BC430 use only AC line plug adapters or AC line cords that comply with local safety regulations.

⚠ Max. Input Voltage at Voltage Banana Inputs to ground:

Input A (L1), B (L2), C (L3), N to GND:

..... 1000 V Cat III, 600 V Cat IV

⚠ Max. Voltage at Current BNC Inputs (See marking):

Input A (L1), B (L2), C (L3), N to GND:..... 42 V peak

Voltage ratings are given as “working voltage”. They should be read as V ac rms (50-60 Hz) for AC sine wave applications and as V dc for DC applications.

Measurement Category IV refers to the overhead or underground utility service of an installation. Cat III refers to distribution level and fixed installation circuits inside a building.

Note

To accommodate connection to various line power sockets, the BC430 Battery Charger / Power Adapter is equipped with a male plug that must be connected to a line plug adapter appropriate for local use. Since the Charger is isolated, you can use line plug adapters with or without a protective ground terminal.

The 230 V rating of the BC430 is not for use in North America. A line plug adapter complying with the applicable National Requirements may be provided to alter the blade configurations for a specific country.

If Safety Features are Impaired

If the Analyzer is used in a manner not specified by the manufacturer, the protection provided by the Analyzer may be impaired.

Before use, inspect the test leads for mechanical damage and replace damaged test leads!

If the Analyzer or its accessories appear to be impaired or not functioning properly, do not use it and send it in for repair.

Reference to Manual Sections

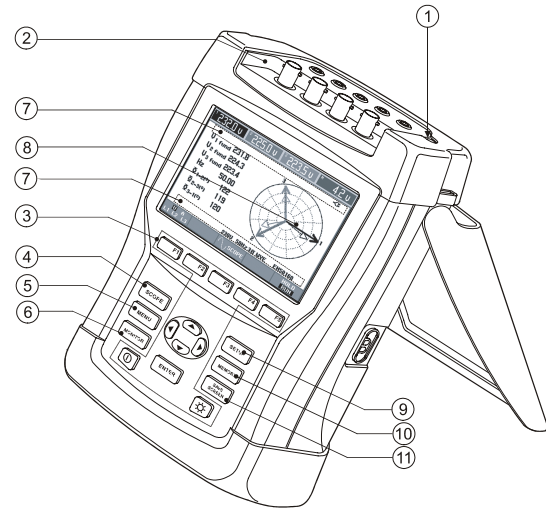

	Subject	Page
①	Charging Batteries, Preparing for Use.	4
②	Input Connections.	7
③	Auxiliary Functions, Menu Navigation.	5
④	SCOPE Mode.	8
⑤	Measurements MENU.	8
⑥	Power Quality MONITOR.	10
⑦	Screen Symbols.	11
⑧	Screens and Function Keys.	12
⑨	Setting up the Analyzer, SETUP.	17
⑩	MEMORY Use.	18
⑪	SAVE Screens.	18

Before making any measurements, set the Analyzer up for the line voltage, frequency, and wiring configuration of the power system you want to measure. This is explained in section 'Setting up the Analyzer'.

Charging the Batteries and Preparing for Use

At delivery, the installed rechargeable NiMH batteries may be empty. To reach full charge they must be charged for at least 4 hours with the Analyzer turned off:

- use only the supplied Battery Charger/Power Adapter model BC430.
- before use check that the BC430 voltage and frequency range match the local line power range (refer to figure below). If necessary set the slider switch of BC430 to the correct voltage.
- connect the battery charger to the AC outlet.
- connect the battery charger to the POWER ADAPTER input on the top side of the Analyzer.

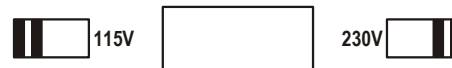

Caution

To obtain maximum capacity of the battery, charge the batteries at least twice a year.

When using your Analyzer for the first time, you must set it up for the measurements you want to make. Section 'Setting up the Analyzer' gives an overview of items to be adjusted.

Tilt Stand

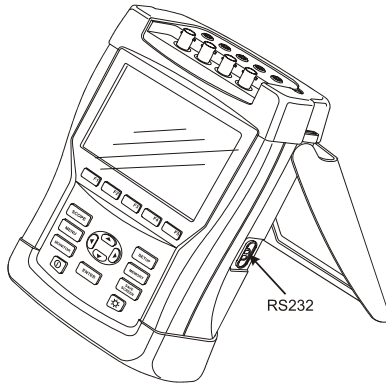

The Analyzer has a tilt stand that allows viewing the screen at an angle when placed on a flat surface. With the tilt stand folded out, the optical port at the right side of the Analyzer can be accessed.

Hang Strap

A hang strap is supplied with the Analyzer. The figure below shows how to attach the strap correctly to the Analyzer.

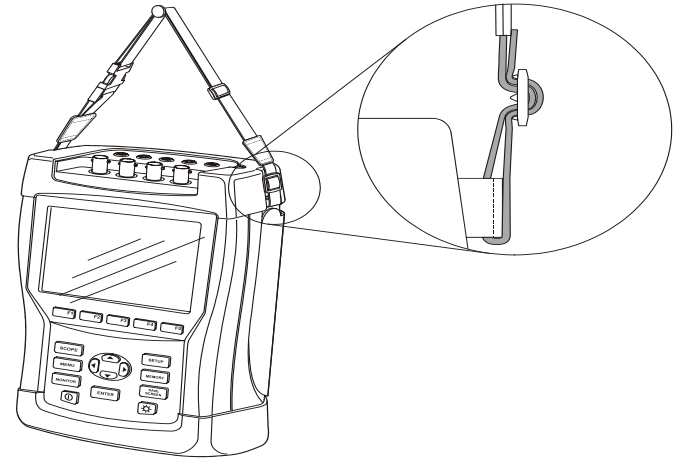

Auxiliary Functions

Power on/off, Brightness adjustment, and Locking the keyboard are explained below:

Power On/Off:



The Analyzer powers up or down with its last setup configuration. Power-on is indicated by a single beep.

Brightness:



Press to dim or brighten the backlight. Dimmed brightness saves battery power. For extra brightness keep pressed for 5 seconds.

Contrast adjustment of the display is explained in the next section as a part of 'Menu Navigation'.

Lock keyboard for unattended measurements:

ENTER

Press for 5 seconds to lock () or unlock the keyboard.

Reset of the Analyzer to factory default settings is explained in section 'Setting up the Analyzer'.

Menu Navigation

Selection of measuring functions and adjustment of settings is done via screen menus. How to use these menus is illustrated below.

As an example setting the Date of the Real Time Clock and Contrast adjustment are explained:

Date adjustment:

SETUP

The SETUP menu pops up.



Use the up/down arrow keys to highlight 'Date'. The current date shown.

ENTER

Press to access the DATE ADJUST submenu.



Highlight 'Day'.



Adjust the Date.



Use the arrow keys to highlight the preferred date representation: Day/Month/Year or Month/Day/Year.

F5

Press function key F5 three times to confirm the selections and to return to the SETUP menu.

Contrast adjustment:

F4

Press function key F4 to access the submenu where CONTRAST can be adjusted.



Adjust CONTRAST to your preference.

F5

Press repeatedly to move upwards through the menus.

Input Connections

The Analyzer has 4 BNC-inputs for current clamps and 5 banana-inputs for voltages.

Self-adhesive decals are supplied corresponding to wiring color codes used in the USA, Canada, Continental Europe, the UK, and China. Stick the decals that fit to your local wiring codes around the current and voltage inputs.

De-energize power systems before making connections whenever possible. Avoid working alone and work according to the warnings listed in section 'Safety Information'.

For a 3-phase system make the connections as shown in Figure 1. First put the current clamps around the conductors of phase A (L1), B (L2), C (L3), and N(utral). The clamps are marked with an arrow indicating the correct signal polarity.

Next make the voltage connections: start with Ground and then in succession N, A (L1), B (L2), and C (L3). For correct measuring results, always connect the Ground input. Always double-check the connections. Make sure that current clamps are secured and completely closed around the conductors.

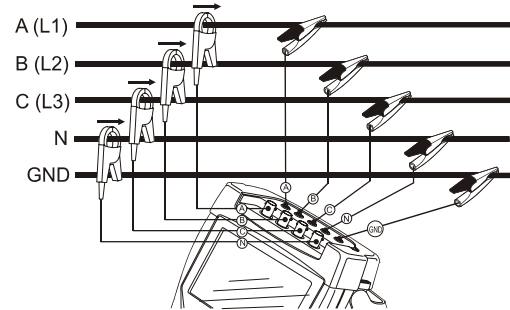

Figure 1. Connection of Analyzer to 3-phase distribution system

For single phase measurements, use current input A (L1) and the voltage inputs Ground, N(utral), and phase A (L1).

A (L1) is the reference phase for all measurements.

Before making any measurements, set the Analyzer up for the line voltage, frequency, and wiring configuration of the power system you want to measure. This is explained in section 'Setting up the Analyzer'.

Measuring Modes, a Quick Overview

This section gives an overview of all measuring modes. The Analyzer's screen information and use of function keys is explained in more detail in the next two chapters.

SCOPE SCOPE MODE. The following features are available:

Measuring Mode	Screen Type	Representation of Measuring Results	Cursor/Zoom
Scope Waveform	Waveform	Oscilloscope display of voltage/current + numerical values.	Yes / Yes
Scope Phasor	Vector Diagram	Voltage/current phase relation + numerical values	No / No

MENU MEASUREMENTS MENU. Measuring Functions accessible via the MENU key. The following features are available:

Measuring Mode	Screen Type	Representation of Measuring Results	Cursor/Zoom
V/A/Hz	Meter screen	Numerical values: voltage, current, frequency, crest factor.	No / No
	Trend	Trend over time of values in the Meter screen.	Yes / Yes
Dips & Swells	Trend	Trend over time with fast update rate: Voltage/current.	Yes / Yes
	Events table	Records events that violate limits: normal/detailed tables available.	No / No
Harmonics	Bar Graphs	Voltage/current/power harmonics, interharmonics, THD, DC	Yes/ No
	Meter screen	Numerical values of a set of (inter)harmonics	No / No
Power & Energy	Meter screen	Numerical values: Active power/Apparent power/ Reactive power /Power factor/Displacement power factor/ Voltage/Current/Energy usage, Energy meter output pulse count	No / No
	Trend	Trend over time of the values in the Meter screen	Yes / Yes

Measuring Mode	Screen Type	Representation of Measuring Results	Cursor/Zoom
Flicker	Meter screen	Numerical values: Short/Long term flicker, Dc, Dmax, TD	No / No
	Trend	Trend over time of values in the Meter screen	Yes / Yes
Unbalance	Meter screen	Numerical values: Voltage/current unbalance (relative %, absolute), Voltage/current fundamental, Phase angle.	No / No
	Trend	Trend over time of values in the Meter screen	Yes / Yes
	Vector Diagram	Voltage/current phase relation + numerical values	No / No
Transients	Waveform	Voltage/current waveforms + numerical values. Records events that violate adjustable limits.	Yes / Yes
Inrush Current	Trend	Records events that exceed adjustable limits.	Yes / Yes
Mains Signaling	Trend	Trend over time of occurrences of frequency 1 and 2 control signals (amplitude, duration).	Yes / Yes
	Events Table	Records Date, Time, Type, Level, and Duration of events.	No / No
Logger	Trend	Trend over time of selected readings (min, max, average)	Yes/Yes
	Meter screen	Numerical values: all selected readings	No / No
	Events Table	Records events that violate limits: normal/detailed tables available.	No / No

Fluke 434/435
Getting Started

MONITOR







POWER QUALITY MONITOR. The following features are available:



Measuring Mode	Screen Type	Representation of Measuring Results	Cursor/Zoom
Main screen	Bar Graphs	Via start menu: overview of key Power Quality metrics. Detailed information available under function keys F1 (V rms), F2 (Harmonics), F3 (Flicker), F4 (Dips, Interruptions, Rapid Voltage Changes, Swells), and F5 (Unbalance, Frequency, Mains Signaling).	Yes / No
	Events Table Trend Bar Graphs	Records events that violate limits: normal/detailed tables available. Trend over time of data group as selected by F1 ... F5. Detailed bar graph for harmonics.	No / No Yes / Yes Yes / No

Screen Symbols







Symbols may appear in the upper and the lower screen areas to show the state of Analyzer and measurements.

Status Indicators in the upper screen area:

	Indication that the 150/180 cycle (3 s) aggregation interval (50/60 Hz) is active.
 -9999:59:59	Time that a measurement has been going on. Format: hours, minutes, seconds. When waiting for a timed start, time counts down with prefix -.
 2x	Horizontal ZOOM on.
	Measurement may be unstable. E.g. for frequency readout during absence of voltage at reference phase A (L1).
	Indicates according to IEC61000-4-30 flagging convention that a dip, swell or interruption has occurred during the displayed aggregation interval. Indicates that an aggregated value may not be reliable.
	Recording of measurement data is on.

	Phasor rotation / phase sequence indicator.
	Battery/Line power indication. During battery operation the battery charge condition is displayed.
	Keyboard locked. Press ENTER 5 seconds to unlock/unlock.

Status line in the lower screen area:

	Date of Analyzer's real time clock. Date format may be month-day-year or day-month-year.
	Time of day or cursor time.
	Nominal line voltage and frequency: the reference for measurements.
	GPS signal strength indicator.
	Number of phases and wiring configuration for the measurement.
	Name of the limits used for power quality MONITOR, dips, swells, interruptions, rapid voltage changes.

Screens and Function Keys

The Analyzer has five different screen types to show measuring results. Each screen type is arranged to present data in the clearest way. Phases are indicated with individual colors.

Selections are done with arrow and function keys: an active selection is highlighted by a black background. Each screen and its features are explained below. Read this carefully to get acquainted with all functions of your Analyzer.

METER screen

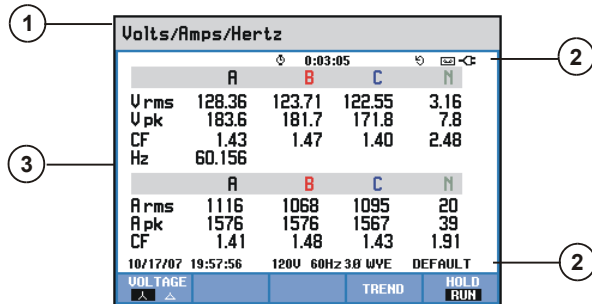

This screen gives a quick overview of important numerical measuring values. An example is the Meter screen belonging to VOLTS/AMPS/HERTZ mode.

Screen information:

①	Active Measuring Mode in header.
②	Status Indicators and Status Line.
③	Field with Measuring values. Contents depends on measuring mode, number of phases, and wiring configuration.

Function keys:

F1	Switches between voltage readout per phase (A/L1,B/L2,C/L3,N) or phase-to-phase (AB,BC,CA) for 3-phase Y configuration.
F4	Access to the TREND screen. For description see below.
F5	Switches between HOLD and RUN of waveform update. Switching from HOLD to RUN invokes a menu to select immediate start (NOW) or TIMED start which allows you to define start time and duration of the measurement.

TREND screen.

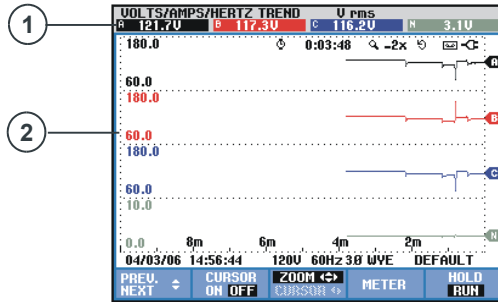

The Trend screen shows the changes over time of measuring values on one row of the Meter screen. An example is the VOLTS/AMPS/HERTZ TREND. Time is displayed horizontally. The display is built up from the right side of the screen. To allow continuous recording of data, the time axis is compressed when necessary.

Screen information:

- ① Present values of the trend graphs on the right side of the screen. If CURSOR is ON, the trend values at the cursor are displayed.
- ② Trend display area.

Function keys:

- F1 Assigns up/down arrow keys to select a row from the Meter screen to be displayed as a trend. The selected row is indicated in screen header.
- F2 CURSOR ON/OFF.
- F3 Assigns the arrow keys to CURSOR or ZOOM operation. Moving the cursor across the extreme left or right of the screen makes the next screen out of a maximum of 6 visible. ZOOM allows you to expand or shrink the display to view details or to see the complete graph within the screen area.
- F4 Return to previous screen.
- F5 Switches between HOLD and RUN.

WAVEFORM screen

An example is the Scope Waveform screen. Voltage and current waveforms are displayed similar to an oscilloscope.

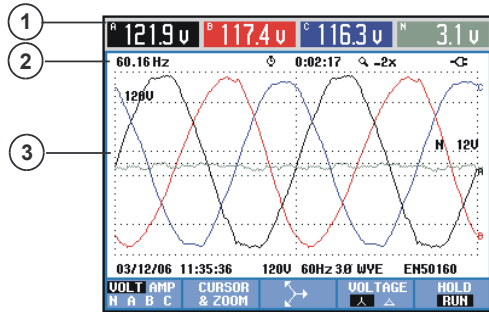

Screen information:

- ① The RMS values of the waveforms are displayed in the header.
- ② Display of measured frequency.
- ③ Waveform display area with grid lines at important voltage/current levels.

Function keys:

F1

Selection of waveform set to be displayed: V displays all voltages, A displays all currents. A (L1), B (L2), C (L3), N (neutral) gives simultaneous display of voltage and current of the selected phase.

F2

Switches to submenu for CURSOR and ZOOM operation.

F3

Switches to the Scope Phasor screen. For description see below.

F4

Switches between voltage readout per phase (A/L1,B/L2,C/L3,N) or phase-to-phase (AB,BC,CA) for 3-phase Y configuration.

F5

Switches between HOLD and RUN.

PHASOR screen.

Shows phase relation between voltages and currents in a vector diagram. An example is the Scope Phasor screen:

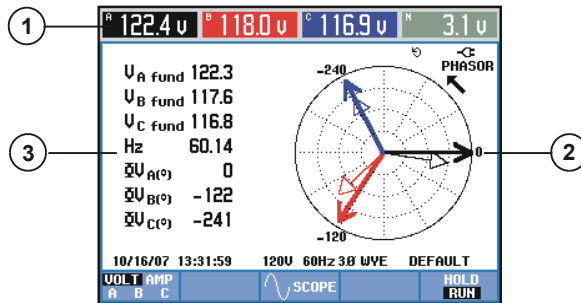

Screen information:

- ① RMS values of the waveforms are displayed in the header.
- ② Vector diagram. The vector of the reference phase A (L1) points to the positive X-direction.
- ③ Additional data such as fundamental phase voltages, frequency, and phase angles.

Function keys:

- | | |
|----|--|
| F1 | Selection of data set to be displayed. |
| F3 | Return to Scope Waveform screen. |
| F5 | Switches between HOLD and RUN. |

BAR GRAPH screen.

An example is the bar graph screen for Power Quality Monitoring. This screen gives a quick indication if important Power Quality parameters meet requirements.

Parameters include RMS voltages, Harmonics, Flicker, Rapid voltage changes, Dips, Swells, Interruptions, Unbalance, Frequency, and Mains Signaling.

The length of a bar increases if the related parameter is further away from its nominal value.

The bar graphs have a wide base (indicating a user definable percentage of the time that a parameter must be within specified levels: for instance 95 % of the readings over 10-minute observation periods must be within level) and a narrow top indicating the fixed 100% limit. If one of these limits is violated, the related bar changes from green to red. Dotted horizontal lines indicate both limits on the display.

Fluke 434/435 Getting Started

You can use a pre-defined set of limits or define your own. An example of a pre-defined set of limits is that according to the EN50160 standard.

Power Quality Monitoring is accessible via the MONITOR key and a menu for immediate or timed start.

Measuring values of the bar graph under the cursor are displayed in the header of the screen.

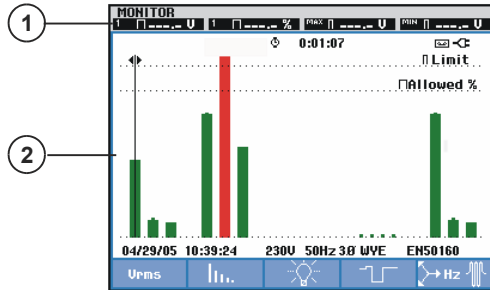

Screen information:

- ① Extreme values of the bar graph under the cursor. Use the left and right arrow key to move the cursor to another bar graph.
- ② Power Quality monitor screen with bars showing the amount of time parameters are within high and low tolerance.

The function keys give access to submenus with detailed information on:

- | | |
|----|---|
| F1 | RMS voltage: events table, trends. |
| F2 | Harmonics: bar graphs, events table, trends. |
| F3 | Flicker: events table, trends. |
| F4 | Dips, Interruptions, Rapid voltage changes, and Swells: events table, trends. |
| F5 | Unbalance, Frequency, and Mains Signaling: events table, trends, and bar graphs for each phase. |

Setting up the Analyzer

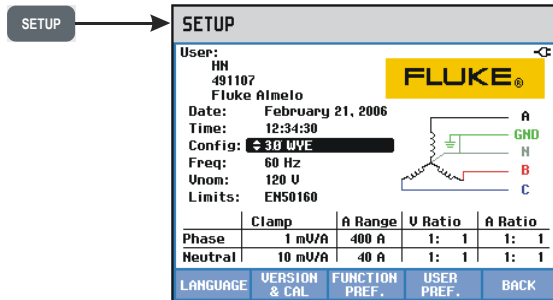

The SETUP key gives access to a menu to configure the Analyzer for your measurements.



Use the arrow keys to select the item you want to adjust: date, time, GPS time sync with optional adapter, wiring configuration, nominal frequency, nominal voltage, limits, current and voltage probe type. User ID is adjusted under F4 USER ID.

ENTER

Press ENTER to reach the selected adjustment menu.



Use the arrow keys to select and adjust the selected item.

F5

Press F5 to confirm the selection and to return to the SETUP menu.

Note: Limits gives access to submenus to recall, customize, and save 6 sets of Power Quality criteria. For detailed information refer to *Chapter 18 in the Users Manual* on the accompanying CD-ROM.

Function keys give access to submenus to adjust:

F1

Displayed information language.

F2

Information on Analyzer Version, Options and Calibration date.

F3

Offset, span, waveform persistence, and other settings to optimize measurements. Adjustment during a measurement is possible to enable better viewing of trends and waveforms. F2: AGGREGATION INTERVAL.

F4

Phase Identification/Colors, Printer type, RS232 interface, Auto display dimming, Memory configuration, reset to FACTORY DEFAULTS, USER ID, display CONTRAST, CLEAR ALL MEMORY.

Memory configuration: allows to optimize memory configuration for logging or for screens/data storage.

F5

Confirm the selections and return to the previous measurement.

Save screens

SAVE
SCREEN

Press to save a screen copy. To recall a screen press the MEMORY key.



Select a file name for the screen to be saved: use the arrow keys to choose characters and their position.

F5

Confirm the selections and return to the previous measurement.

Memory Use

The MEMORY key gives access to a menu to SAVE, RECALL, DELETE Data and Screen copies and to

PRINT. A data file includes screen, trends, Meter screens, settings and limits. You may use cursor and zoom after recall.

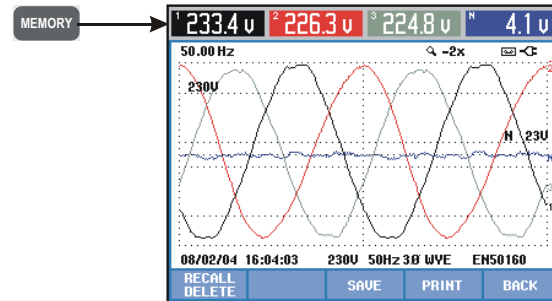

The function keys allow the following selections:

F1

Access to a submenu to recall/delete screens or data.

F3

Saves the current measurement as a Data file.

F4

Prints current screen.

F5

Return to the last measurement.